



# RADIO TEST REPORT

For

Navori SA

Media Player

Test Model: Stix3800

Prepared for : Navori SA  
Address : Avenue mon repos 22, 1005 lausanne, Switzerland

Prepared by : Shenzhen LCS Compliance Testing Laboratory Ltd.  
Address : Room 101, 201, Building A and Room 301, Building C, Juji Industrial Park, Yabianxueziwei, Shajing Street, Bao'an District, Shenzhen, Guangdong, China

Tel : (+86)755-82591330  
Fax : (+86)755-82591332  
Web : www.LCS-cert.com  
Mail : webmaster@LCS-cert.com

Date of receipt of test sample : April 07, 2024  
Number of tested samples : 2  
Sample No. : A240401010-1, A240401010-2  
Serial number : Prototype  
Date of Test : April 07, 2024 ~ April 22, 2024  
Date of Report : April 22, 2024





<b>RADIO TEST REPORT</b>	
<b>ETSI EN 300 440 V2.2.1 (2018-07)</b>	
Short Range Devices (SRD); Radio equipment to be used in the 1 GHz to 40 GHz frequency range; Harmonised Standard for access to radio spectrum	
<b>Report Reference No.</b> .....	<b>: LCSA04014116EH</b>
Date of Issue.....	: April 22, 2024
<b>Testing Laboratory Name</b> .....	<b>: Shenzhen LCS Compliance Testing Laboratory Ltd.</b>
Address.....	: Room 101, 201, Building A and Room 301, Building C, Juji Industrial Park, Yabianxueziwei, Shajing Street, Bao'an District, Shenzhen, Guangdong, China
Testing Location/ Procedure....	: Full application of Harmonised standards <input checked="" type="checkbox"/> Partial application of Harmonised standards <input type="checkbox"/> Other standard testing method <input type="checkbox"/>
<b>Applicant's Name</b> .....	<b>: Navori SA</b>
Address.....	: Avenue mon repos 22, 1005 lausanne, Switzerland
<b>Test Specification</b>	
Standard.....	: ETSI EN 300 440 V2.2.1 (2018-07)
Test Report Form No. ....	: LCSEMC-1.0
TRF Originator.....	: Shenzhen LCS Compliance Testing Laboratory Ltd.
Master TRF.....	: Dated 2017-06
<b>Shenzhen LCS Compliance Testing Laboratory Ltd. All rights reserved.</b>	
This publication may be reproduced in whole or in part for non-commercial purposes as long as the Shenzhen LCS Compliance Testing Laboratory Ltd. is acknowledged as copyright owner and source of the material. Shenzhen LCS Compliance Testing Laboratory Ltd. takes no responsibility for and will not assume liability for damages resulting from the reader's interpretation of the reproduced material due to its placement and context.	
<b>Test Item Description</b> .....	<b>: Media Player</b>
Trade Mark.....	: Navori
Test Model.....	: Stix3800
Ratings.....	: Input: DC 5V, 2A
<b>Result</b> .....	<b>: Positive</b>

**Compiled by:**

*Joker.Hu*

Joker Hu/ Administrator

**Supervised by:**

*Cary Luo*

Cary Luo/ Technique principal

**Approved by:**

*Gavin Liang*

Gavin Liang/ Manager





# RADIO -- TEST REPORT

<b>Test Report No. :</b> LCSA04014116EH	<u>April 22, 2024</u> Date of issue
---	--

<p>Test Model..... : Stix3800</p> <p>EUT..... : Media Player</p>
<p><b>Applicant..... : Navori SA</b></p> <p>Address..... : Avenue mon repos 22, 1005 lausanne, Switzerland</p> <p>Telephone..... : /</p> <p>Fax..... : /</p>
<p><b>Manufacturer..... : Shenzhen Geniatech INC., Ltd.</b></p> <p>Address..... : Room 02-04, 10/F, Block A, Building 8, Shenzhen International Innovation Valley, Dashi Road, Nanshan District, Shenzhen, Guangdong, China.</p> <p>Telephone..... : /</p> <p>Fax..... : /</p>
<p><b>Factory ..... : Shenzhen Geniatech INC., Ltd.</b></p> <p>Address ..... : 2F Block A, Yinghaosheng Industrial park,Fu'an Road,Dayang Development Zone,Fuyong Town, Bao'an District, Shenhen, China.</p> <p>Telephone..... : /</p> <p>Fax..... : /</p>

<b>Test Result</b>	<b>Positive</b>
--------------------	-----------------

The test report merely corresponds to the test sample.  
It is not permitted to copy extracts of these test result without the written permission of the test laboratory.





### Revision History

Report Version	Issue Date	Revision Content	Revised By
000	April 22, 2024	Initial Issue	---





# TABLE OF CONTENTS

- 1. GENERAL INFORMATION ..... 6**
  - 1.1. PRODUCT DESCRIPTION FOR EQUIPMENT UNDER TEST (EUT) ..... 6
  - 1.2. OBJECTIVE ..... 8
  - 1.3. RELATED SUBMITTAL(S)/GRANT(S) ..... 8
  - 1.4. TEST METHODOLOGY ..... 8
  - 1.5. FACILITIES ..... 8
  - 1.6. SUPPORT EQUIPMENT LIST ..... 8
  - 1.7. EXTERNAL I/O ..... 8
  - 1.8. LABORATORY ACCREDITATIONS AND LISTINGS ..... 9
  - 1.9. MEASUREMENT UNCERTAINTY ..... 9
  - 1.10. TEST ENVIRONMENT ..... 9
  - 1.11. DESCRIPTION OF TEST MODES ..... 10
  - 1.12. TEST CONDITIONS ..... 10
- 2. SYSTEM TEST CONFIGURATION ..... 11**
  - 2.1. JUSTIFICATION ..... 11
  - 2.2. EUT EXERCISE SOFTWARE ..... 11
  - 2.3. SPECIAL ACCESSORIES ..... 11
  - 2.4. BLOCK DIAGRAM/SCHEMATICS ..... 11
  - 2.5. EQUIPMENT MODIFICATIONS ..... 11
  - 2.6. CONFIGURATION OF TEST SETUP ..... 11
- 3. SUMMARY OF TEST RESULTS ..... 12**
- 4. TEST RESULTS ..... 13**
  - 4.1. EQUIVALENT ISOTROPICALLY RADIATED POWER (EIRP) ..... 13
  - 4.2. PERMITTED RANGE OF OPERATING FREQUENCIES ..... 15
  - 4.3. DUTY CYCLE ..... 16
  - 4.4. UNWANTED EMISSIONS IN THE SPURIOUS DOMAIN ..... 18
  - 4.5. ADJACENT CHANNEL SELECTIVITY ..... 20
  - 4.6. BLOCKING OR DESENSITIZATION ..... 21
  - 4.7. SPURIOUS RADIATIONS ..... 22
- 5. MEASUREMENT UNCERTAINTY ..... 23**
- 6. PHOTOGRAPHS OF TEST SETUP ..... 24**
- 7. PHOTOGRAPHS OF THE EUT ..... 24**





## 1. GENERAL INFORMATION

### 1.1. Product Description for Equipment Under Test (EUT)

EUT	: Media Player
Test Model	: Stix3800
Power Supply	: Input: DC 5V, 2A
Hardware Version	: RKN231219_V1.1
Software Version	: rk3568_r_0319
Bluetooth	:
Frequency Range	: 2402MHz ~ 2480MHz
Channel Number	: 79 channels for Bluetooth V5.0 (BDR/EDR) 40 channels for Bluetooth V5.0 (BT LE/BT 2LE)
Channel Spacing	: 1MHz for Bluetooth V5.0 (BDR/EDR) 2MHz for Bluetooth V5.0 (BT LE/BT 2LE)
Modulation Type	: GFSK, $\pi/4$ -DQPSK, 8-DPSK for Bluetooth V5.0 (BDR/EDR) GFSK for Bluetooth V5.0 (BT LE/BT 2LE)
Bluetooth Version	: V5.0
Antenna Description	: FPC Antenna, 1.99dBi(Max.)
WIFI(2.4G Band)	:
Frequency Range	: 2412MHz ~ 2472MHz
Channel Spacing	: 5MHz
Channel Number	: 13 Channel for 20MHz bandwidth(2412~2472MHz) 9 channels for 40MHz bandwidth(2422~2462MHz)
Modulation Type	: 802.11b: DSSS; 802.11g/n: OFDM
Antenna Description	: FPC Antenna, 1.99dBi(Max.)
WIFI(5.2G Band)	:
Frequency Range	: 5180MHz~5240MHz
Channel Number	: 4 channels for 20MHz bandwidth(5180~5240MHz) 2 channels for 40MHz bandwidth(5190~5230MHz) 1 channels for 80MHz bandwidth(5210MHz)
Modulation Type	: 802.11a/n: OFDM (64QAM, 16QAM, QPSK, BPSK) 802.11ac: OFDM (256QAM, 64QAM, 16QAM, QPSK, BPSK)
Antenna Description	: FPC Antenna, 2.46dBi(Max.)
WIFI(5.3G Band)	:
Frequency Range	: 5260MHz~5320MHz
Channel Number	: 4 Channels for 20MHz bandwidth(5260MHz~5320MHz) 2 channels for 40MHz bandwidth(5270MHz~5310MHz)





1 channels for 80MHz bandwidth(5290MHz)

Modulation Type : 802.11a/n: OFDM (64QAM, 16QAM, QPSK, BPSK)  
802.11ac: OFDM (256QAM, 64QAM, 16QAM, QPSK, BPSK)

Antenna Description : FPC Antenna, 2.46dBi(Max.)

WIFI(5.5G Band) :

Frequency Range : 5500MHz ~5700MHz

Channel Number : 11 Channels for 20MHz bandwidth(5500MHz~5700MHz)  
5 Channels for 40MHz bandwidth(5510MHz~5670MHz)  
2 Channels for 80MHz bandwidth(5530MHz~5610MHz)

Modulation Type : 802.11a/n: OFDM (64QAM, 16QAM, QPSK, BPSK)  
802.11ac: OFDM (256QAM, 64QAM, 16QAM, QPSK, BPSK)

Antenna Description : FPC Antenna, 2.46dBi(Max.)

WIFI(5.8G Band) :

Frequency Range : 5745MHz ~ 5825MHz

Channel Number : 5 channels for 20MHz bandwidth(5745~5825MHz)  
2 channels for 40MHz bandwidth(5755~5795MHz)  
1 channels for 80MHz bandwidth(5775MHz)

Modulation Type : 802.11a/n: OFDM (64QAM, 16QAM, QPSK, BPSK)  
802.11ac: OFDM (256QAM, 64QAM, 16QAM, QPSK, BPSK)

Antenna Description : FPC Antenna, 2.46dBi(Max.)





### 1.2. Objective

This Type approval report is prepared on behalf of **Navori SA** in accordance with ETSI EN 300 440 V2.2.1 (2018-07), Short Range Devices (SRD); Radio equipment to be used in the 1 GHz to 40 GHz frequency range; Harmonised Standard for access to radio spectrum.

The objective is to determine compliance with ETSI EN 300 440 V2.2.1 (2018-07).

### 1.3. Related Submittal(s)/Grant(s)

No Related Submittals.

### 1.4. Test Methodology

All measurements contained in this report were conducted with ETSI EN 300 440 V2.2.1 (2018-07).

### 1.5. Facilities

All measurement facilities used to collect the measurement data are located at Room 101, 201, Building A and Room 301, Building C, Juji Industrial Park, Yabianxueziwei, Shajing Street, Bao'an District, Shenzhen, Guangdong, China

The sites are constructed in conformance with the requirements of ANSI C63.7, ANSI C63.4 and CISPR Publication 32.

### 1.6. Support Equipment List

Manufacturer	Description	Model	Serial Number	Certificate
Shenzhen Meike Star communication Technology Co., LTD	ADAPTER	M535122-2X1	---	CE
Lenovo	PC	TP00094A	---	CE

Note: PC is supplied by lab and only used test.

### 1.7. External I/O

I/O Port Description	Quantity	Cable
Type-C USB Port	1	N/A
USB Port	2	N/A
POE Port	2	N/A
HDMI Port	1	N/A
TF Card Port	1	N/A





### 1.8. Laboratory Accreditations And Listings

Site Description

EMC Lab. : NVLAP Accreditation Code is 600167-0.  
 FCC Designation Number is CN5024.  
 CAB identifier is CN0071.  
 CNAS Registration Number is L4595.

### 1.9. Measurement Uncertainty

Test Item	Uncertainty
Radio Frequency	0.9 x 10 <sup>-4</sup>
Total RF Power, Conducted	1.0 dB
RF Power Density, Conducted	1.8 dB
Spurious Emissions, Conducted	1.8 dB
All Emissions, Radiated	3.1 dB
Temperature	0.5°C
Humidity	1 %
DC And Low Frequency Voltages	1 %

### 1.10. Test Environment

Items	Required (IEC 68-1)	Actual
Temperature (°C)	15-35	23.3
Humidity (%RH)	25-75	53.6
Barometric pressure (mbar)	860-1060	950-1000





### 1.11. Description Of Test Modes

LCS has verified the construction and function in typical operation. All the test modes were carried out with the EUT in normal operation, which was shown in this test report and defined as:

Test Mode
Mode 1: Transmit by 802.11a
Mode 2: Transmit by 802.11n(20MHz)
Mode 3: Transmit by 802.11n(40MHz)
Mode 4: Transmit by 802.11ac(20MHz)
Mode 5: Transmit by 802.11ac(40MHz)
Mode 6: Transmit by 802.11ac(80MHz)
Mode 7: Receive by 802.11a
Mode 8: Receive by 802.11n(20MHz)
Mode 9: Receive by 802.11n(40MHz)
Mode 10: Receive by 802.11ac(20MHz)
Mode 11: Receive by 802.11ac(40MHz)
Mode 11: Receive by 802.11ac(80MHz)

Note:

- (1) For portable device, radiated spurious emission was verified over X, Y, Z Axis, and shown the worst case on this report.
- (2) Regard to the frequency band operation for systems using Wide Band modulation: the lowest, middle, highest frequency channel for conducted test, and the lowest, highest frequency channel for radiation spurious test.
- (3) The extreme test condition for voltage and temperature were declared by the manufacturer.  
 \*\*\*Note: The EUT was programmed to transmit continuously during testing (duty cycle = 100%).

### 1.12. Test Conditions

Conditions	Temperature	Voltage
Normal	21-25°C	DC 5.0V
Low extreme Temperature/Low extreme Voltage (TL/VL);	-20°C	DC 5.5V
Low extreme Temperature/High extreme Voltage (TL/VH);	-20°C	DC 4.5V
High extreme Temperature/Low extreme Voltage (TH/VL);	45°C	DC 5.5V
High extreme Temperature/High extreme Voltage (TH/VH).	45°C	DC 4.5V

Note1: The High Voltage DC 4.5V and Low Voltage DC 5.5V was declared by manufacturer





## 2. SYSTEM TEST CONFIGURATION

### 2.1. Justification

The system was configured for testing in engineering mode.

### 2.2. EUT Exercise Software

N/A.

### 2.3. Special Accessories

N/A.

### 2.4. Block Diagram/Schematics

Please refer to the related document.

### 2.5. Equipment Modifications

Shenzhen LCS Compliance Testing Laboratory Ltd. has not done any modification on the EUT.

### 2.6. Configuration of Test Setup

Please refer to the test setup photo.





### 3. SUMMARY OF TEST RESULTS

RULES ETSI EN 300 440 V2.2.1 (2018-07)	DESCRIPTION OF TEST	RESULT
§ 4.2.2	Equivalent isotropically radiated power (EIRP)	Compliant
§ 4.2.3	Permitted range of operating frequencies	Compliant
§ 4.2.4	Unwanted emissions in the spurious domain	Compliant
§ 4.2.5	Duty cycle	Compliant
§ 4.3.3	Adjacent channel selectivity	Compliant
§ 4.3.4	Blocking or desensitization	Compliant
§ 4.3.5	Spurious radiations	Compliant
§ 4.4	Spectrum access techniques	N/A

Note: "N/A" means this test item is not applicable.





## 4. TEST RESULTS

### 4.1. Equivalent Isotropically Radiated Power (EIRP)

#### 4.1.1 Definition and Limit

The e.i.r.p. is defined as the maximum radiated power of the transmitter and its antenna . The transmitter maximum e.i.r.p. under normal and extreme test conditions shall not exceed the values given in following table.

Entry	Frequency Bands	Power	Application	Notes
1	2 400 MHz to 2 483,5 MHz	10 mW e.i.r.p.	Non-specific short range devices	
2	2 400 MHz to 2 483,5 MHz	25 mW e.i.r.p.	Radiodetermination devices	
3	(a) 2 446 MHz to 2 454 MHz	500 mW e.i.r.p.	Radio Frequency Identification (RFID) devices	See also table 4 and Annex G
4	(b) 2 446 MHz to 2 454 MHz	4 W e.i.r.p.	Radio Frequency Identification (RFID) devices	See also table 4 and Annex G
5	5 725 MHz to 5 875 MHz	25 mW e.i.r.p.	Non-specific short range devices	
6	9 200 MHz to 9 500 MHz	25 mW e.i.r.p.	Radiodetermination devices	
7	9 500 MHz to 9 975 MHz	25 mW e.i.r.p.	Radiodetermination devices	
8	10,5 GHz to 10,6 GHz	500 mW e.i.r.p.	Radiodetermination devices	
9	13,4 GHz to 14,0 GHz	25 mW e.i.r.p.	Radiodetermination devices	
10	17,1 GHz to 17,3 GHz	400 mW e.i.r.p.	Radiodetermination devices	See Annex H
11	24,00 GHz to 24,25 GHz	100 mW e.i.r.p.	Non-specific short range devices and radiodetermination devices	
NOTE: The spectrum ranges in some entries are not harmonised throughout all EU territory, specifically entries 4, 9, and 11 have been identified as such. Implementers are cautioned to refer to CEPT/ERC Recommendation 70-03 [i.2] as well as current National Radio plans to verify acceptance within intended regions of use.				



#### 4.1.2 Test Procedure

The equipment shall be able to operate in a continuous transmit mode for testing purposes. Please refer to ETSI EN 300 440 V2.2.1 (2018-07) clause 4.2.2.3 for the measurement method.

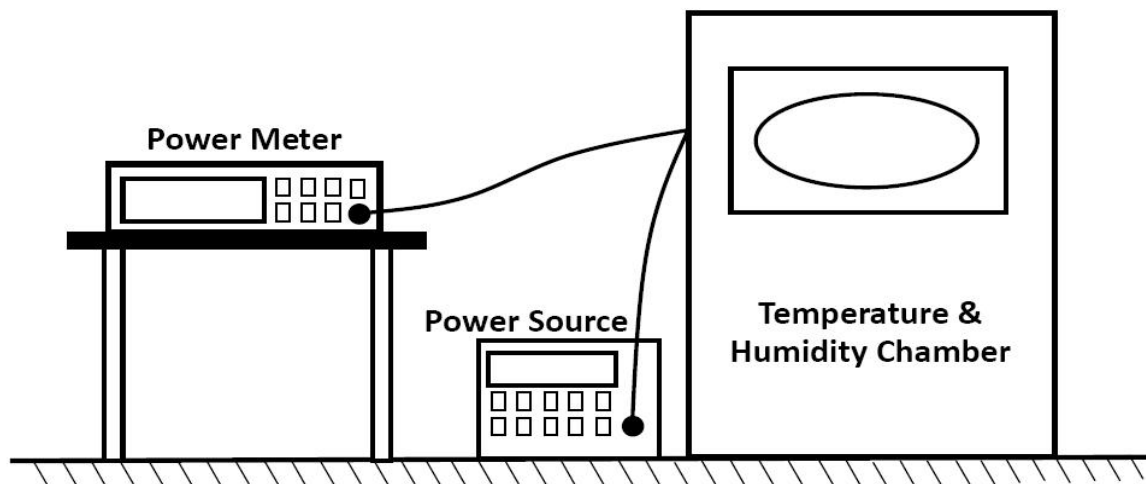

#### 4.1.3 Test Result

Please refer to the Appendix K.1 for 5.8G WIFI RF Test Data.



## 4.2. Permitted Range of Operating Frequencies

### 4.2.1 Definition and Limit

The permitted range of operating frequencies includes all frequencies on which the equipment may operate within an assigned frequency band. The operating frequency range shall be declared by the manufacturer.

The width of the power envelope is  $f_H - f_L$  for a given operating frequency. In equipment that allows adjustment or selection of different operating frequencies, the power envelope takes up different positions in the allowed band. The frequency range is determined by lowest value of  $f_L$  and the highest value of  $f_H$  resulting from the adjustment of the equipment to the lowest and highest operating frequencies.

### 4.2.2 Test Procedure

The equipment shall be able to operate in a continuous transmit mode for testing purposes. Please refer to ETSI EN 300 440 V2.2.1 (2018-07) clause 4.2.3.3 for the measurement method.

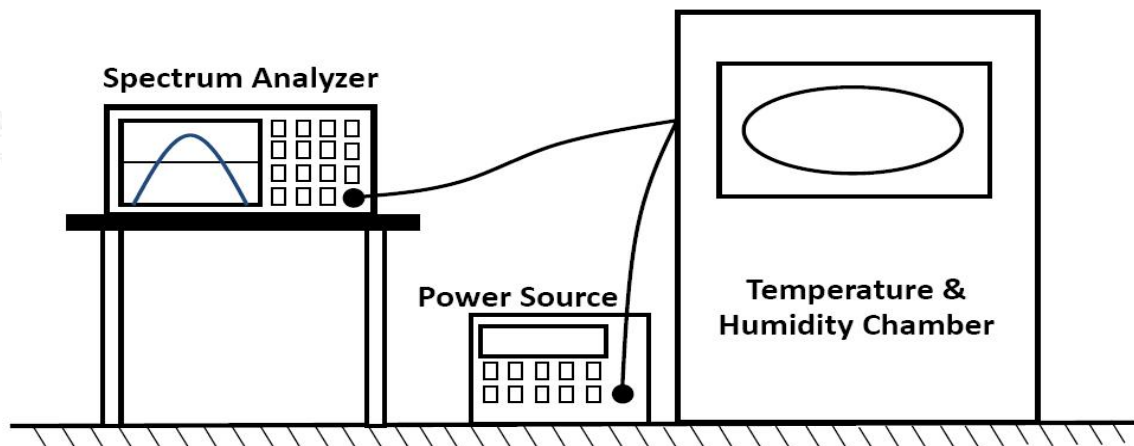

### 4.2.3 Test Result

Please refer to the Appendix K.2 for 5.8G WIFI RF Test Data.





### 4.3. Duty Cycle

#### 4.3.1 Definition and Limit

Duty cycle is the ratio expressed as a percentage, of the cumulative duration of

$$DC = \left( \frac{T_{on\_cum}}{T_{obs}} \right) F_{obs}$$

transmissions  $T_{on\_cum}$  within an observation interval  $T_{obs}$  on an observation bandwidth  $F_{obs}$ .

Unless otherwise specified,  $T_{obs}$  is 1 hour and the observation bandwidth  $F_{obs}$  is the operational frequency band. Each transmission consists of an RF emission, or sequence of RF emissions separated by intervals  $< T_{Dis}$ .

An equipment may operate on several bands simultaneously (i.e. multi transmissions), Duty Cycle of each band applies to each transmission.

In case of a multicarrier modulation in a band, the duty cycle applies to the whole signal used for a transmission (e.g. OFDM).

It has to be noted that on some bands Duty Cycle value may depend on the presence of a primary radio service.

Equipment may be triggered manually, by internal timing or by external stimulus. Depending on the method of triggering the timing may be predictable or random.

The following Table defines the maximum duty cycle within a 1 hour period.

Frequency Band	Duty cycle	Application	Notes
2 400 MHz to 2 483,5 MHz	No Restriction	Generic use	
2 400 MHz to 2 483,5 MHz	No Restriction	Radiodetermination	
(a) 2 446 MHz to 2 454 MHz	No Restriction	RFID	Limits shown in Annex G shall apply
(b) 2 446 MHz to 2 454 MHz	$\leq 15\%$	RFID	Limits shown in Annex G shall apply
5 725 MHz to 5 875 MHz	No Restriction	Generic use	
9 200 MHz to 9 500 MHz	No Restriction	Radiodetermination	
9 500 MHz to 9 975 MHz	No Restriction	Radiodetermination	
10,5 GHz to 10,6 GHz	No Restriction	Radiodetermination	
13,4 GHz to 14,0 GHz	No Restriction	Radiodetermination	
17,1 GHz to 17,3 GHz	DAA or equivalent techniques	Radiodetermination, limited to GBSAR detecting and movement and alert applications	Limits shown in Annex I shall apply
24,00 GHz to 24,25 GHz	No Restriction	Generic use and for radiodetermination	

NOTE: The spectrum ranges in some entries are not harmonised throughout all EU territory, specifically entries 4, 9, and 11 have been identified as such. Implementers are cautioned to refer to CEPT/ERC Recommendation 70-03 [i.2] as well as current National Radio plans to verify acceptance within intended regions of use.

For devices with a 100 % duty cycle transmitting an unmodulated carrier most of the time, a time-out shut-off facility shall be implemented in order to improve the efficient use of spectrum.



Shenzhen LCS Compliance Testing Laboratory Ltd.

Add: Room 101, 201, Building A and Room 301, Building C, Juji Industrial Park, Yabianxueziwei, Shajing Street, Bao'an District, Shenzhen, Guangdong, China

Tel: +(86) 0755-82591330 | E-mail: webmaster@lcs-cert.com | Web: www.lcs-cert.com

Scan code to check authenticity



### 4.3.2 Test Procedure

Please refer to ETSI EN 300 440 V2.2.1 (2018-07) clause 4.2.5.3 for the measurement method.

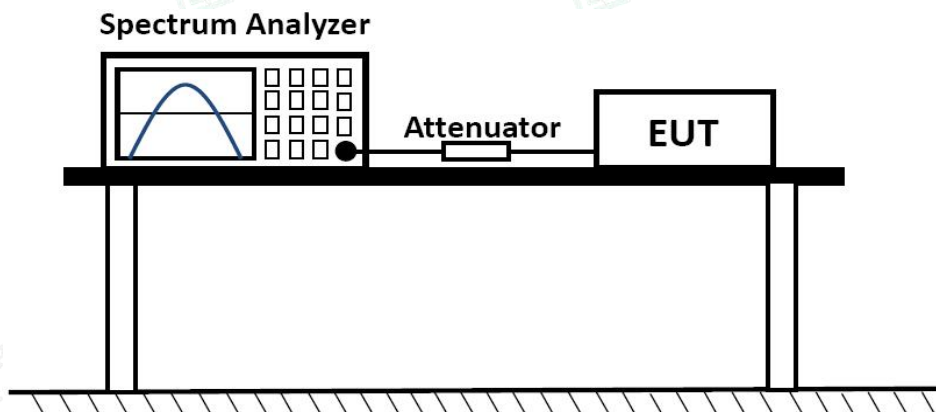

### 4.3.3 Test Result

The EUT was programmed to transmit continuously during testing (duty cycle = 100%).



## 4.4. Unwanted Emissions in the Spurious Domain

### 4.4.1 Definition and Limit

Unwanted emissions in the spurious domain (spurious emissions) are those at frequencies beyond the limit of 250 % of the occupied bandwidth above and below the centre frequency of the emission. The occupied bandwidth is measured as declared by the manufacturer. The spurious emissions of the transmitter shall not exceed the values in following tables:

**Table:** spurious emissions

Frequency ranges	47 MHz to 74 MHz 87,5 MHz to 108 MHz 174 MHz to 230 MHz 470 MHz to 862 MHz	Other frequencies ≤ 1 000 MHz	Frequencies > 1 000 MHz
State			
Operating	4 nW	250 nW	1 μW
Standby	2 nW	2 nW	20 nW

### 4.4.2 Test Procedure

Please refer to ETSI EN 300 440 V2.2.1 (2018-07) clause 4.2.4.3 for the measurement method.

Radiated Below 1GHz

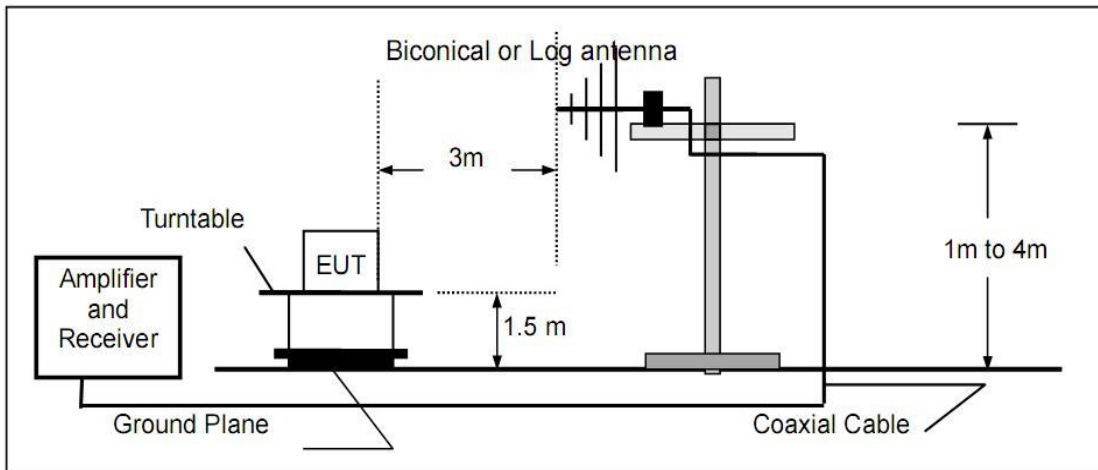

Radiated Above 1GHz

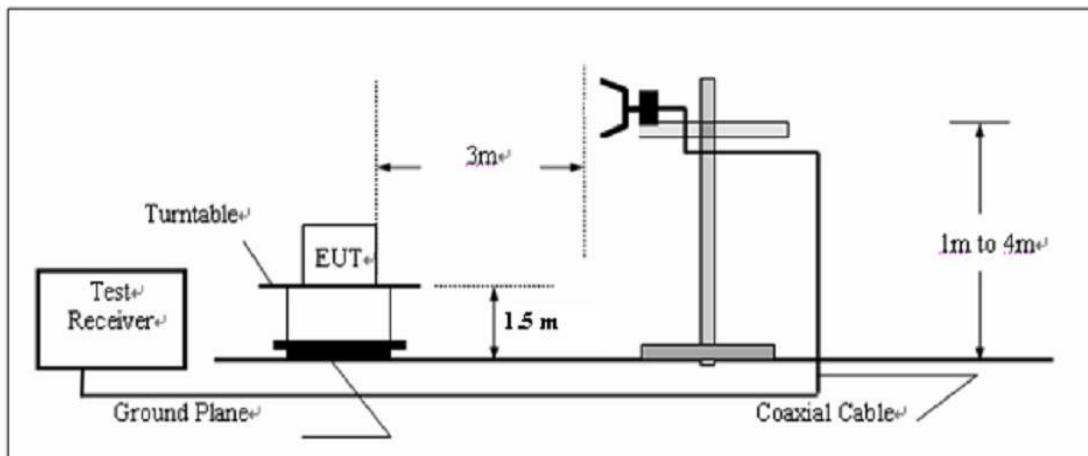

### Substitution Method: (Radiated Emissions)

Radiated Below 1GHz

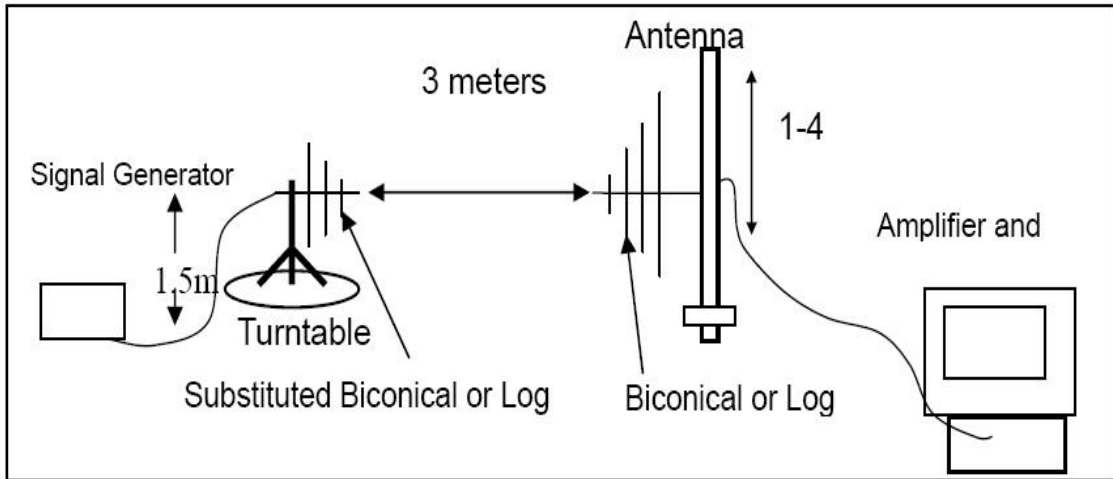

Radiated Above 1 GHz

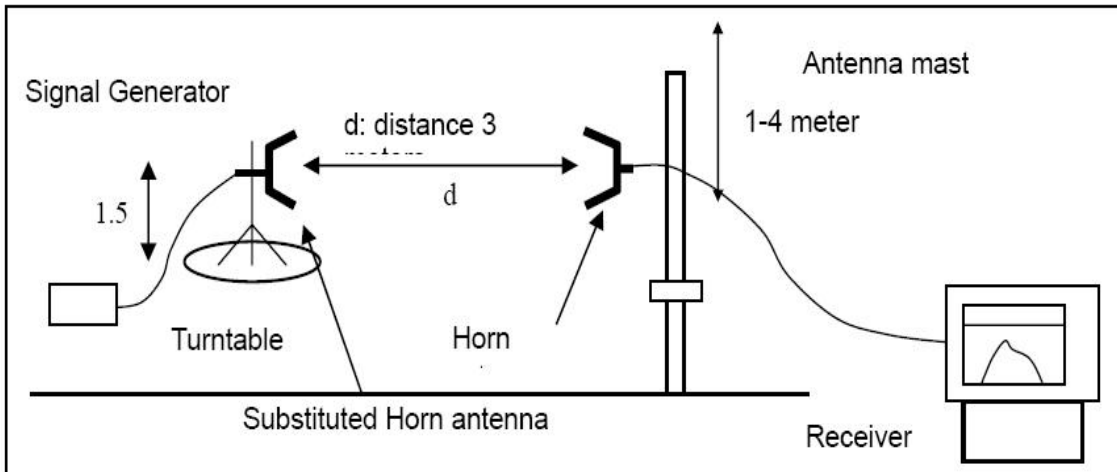

#### 4.4.3 Test Result

Please refer to the Appendix K.3 for 5.8G WIFI RF Test Data.





## 4.5. Adjacent Channel Selectivity

### 4.5.1 Definition and Limit

The adjacent channel selectivity is a measure of the capability of the receiver to operate satisfactorily in the presence of an unwanted signal that differs in frequency from the wanted signal by an amount equal to the adjacent channel separation for which the equipment is intended.

The adjacent channel selectivity of the equipment under specified conditions shall not be less than  $-30 \text{ dBm} + k$ . The correction factor,  $k$ , is as follows:

$$k = -20 \log f - 10 \log BW$$

Where:

- $f$  is the frequency in GHz;
- $BW$  is the channel bandwidth in MHz.

The factor  $k$  is limited within the following:

- $-40 \text{ dB} < k < 0 \text{ dB}$ .

### 4.5.2 Test Procedure

Please refer to ETSI EN 300 440 clause 4.3.3.3 for the measurement method.

### 4.5.3 Test Result

**Please refer to the Appendix K.4 for 5.8G WIFI RF Test Data.**





## 4.6. Blocking or Desensitization

### 4.6.1 Definition and Limit

Blocking is a measure of the capability of the receiver to receive a wanted modulated signal without exceeding a given degradation due to the presence of an unwanted input signal at any frequencies other than those of the spurious responses or the occupied bandwidth.

The blocking level, for any frequency within the specified ranges, shall not be less than the values given in the following table, except at frequencies on which spurious responses are found.

Receiver category	Limit
1	-30 dBm + k
2	-45 dBm + k
3	-60 dBm + k

The correction factor, k, is as follows:

$$k = -20 \log f - 10 \log BW$$

Where:

- f is the frequency in GHz;
- BW is the channel bandwidth in MHz.

The factor k is limited within the following:

$$-40 \text{ dB} < k < 0 \text{ dB}$$

### 4.6.2 Test Procedure

Please refer to ETSI EN 300 440 clause 4.3.4.3 for the measurement method.

### 4.6.3 Test Result

**Please refer to the Appendix K.5 for 5.8G WIFI RF Test Data.**





## 4.7. Spurious Radiations

### 4.7.1 Definition and Limit

Spurious radiations from the receiver are components at any frequency, radiated by the equipment and antenna.

These requirements do not apply to receivers used in combination with permanently co-located transmitters continuously transmitting. Co-located is defined as < 3 m. In these cases the receivers will be tested together with the transmitter in operating mode.

The power of any spurious emission shall not exceed 2 nW in the range 25 MHz to 1 GHz and shall not exceed 20 nW on frequencies above 1 GHz.

### 4.7.2 Test Procedure

Please refer to ETSI EN 300 440 V2.2.1 (2018-07) clause 4.3.5.3 for the measurement method.

### 4.7.3 Test Result

**Please refer to the Appendix K.6 for 5.8G WIFI RF Test Data.**



Shenzhen LCS Compliance Testing Laboratory Ltd.

Add: Room 101, 201, Building A and Room 301, Building C, Juji Industrial Park, Yabianxueziwei, Shajing Street, Bao'an District, Shenzhen, Guangdong, China

Tel: +(86) 0755-82591330 | E-mail: webmaster@lcs-cert.com | Web: www.lcs-cert.com

Scan code to check authenticity



## 5. MEASUREMENT UNCERTAINTY

Item	Equipment	Manufacturer	Model No.	Serial No.	Cal Date	Due Date
1	X-series USB Peak and Average Power Sensor Agilent	Agilent	U2021XA	MY54080022	2023-10-20	2024-10-19
2	4 CH. Simultaneous Sampling 14 Bits 2MS/s	Agilent	U2531A	MY54080016	2023-10-20	2024-10-19
3	Test Software	Ascentest	AT890-SW	20160630	N/A	N/A
4	RF Control Unit	Ascentest	AT890-RFB	N/A	2023-06-09	2024-06-08
5	MXA Signal Analyzer	Agilent	N9020A	MY49061051	2023-06-09	2024-06-08
6	DC Power Supply	Agilent	E3642A	N/A	2023-10-18	2024-10-17
7	MXG Vector Signal Generator	Agilent	N5182A	MY47071151	2023-06-09	2024-06-08
8	ESG Vector Signal Generator	Agilent	E4438C	MY49072627(3 G)	2023-06-09	2024-06-08
9	PSG Analog Signal Generator	Agilent	E8257D	MY4520521	2023-06-09	2024-06-08
10	Temperature & Humidity Chamber	GUANGZHOU GOGNWEN	GDS-100	70932	2023-10-05	2024-10-04
11	EMI Test Software	Farad	EZ	/	N/A	N/A
12	3m Full Anechoic Chamber	MRDIANZI	FAC-3M	MR009	2022-08-17	2025-08-16
13	Positioning Controller	Max-Full	MF7802BS	MF780208586	N/A	N/A
14	Active Loop Antenna	SCHWARZBECK	FMZB 1519B	00005	2021-08-29	2024-08-28
15	By-log Antenna	SCHWARZBECK	VULB9163	9163-470	2021-09-12	2024-09-11
16	Horn Antenna	SCHWARZBECK	BBHA 9120D	9120D-1925	2021-09-05	2024-09-04
17	Broadband Horn Antenna	SCHWARZBECK	BBHA 9170	791	2021-08-29	2024-08-28
18	Broadband Preamplifier	SCHWARZBECK	BBV9719	9719-025	2021-08-29	2024-08-28
19	EMI Test Receiver	R&S	ESR7	101181	2023-08-15	2024-08-14
20	RS SPECTRUM ANALYZER	R&S	FSP40	100503	2023-07-17	2024-07-16
21	Low-frequency amplifier	SchwarzZBECK	BBV9745	00253	2023-10-18	2024-10-17
22	High-frequency amplifier	JS Denki Pte	PA0118-43	JSPA21009	2023-10-18	2024-10-17
23	WIDEBAND RADIO COMMUNICATION TESTER	R&S	CMW 500	103818	2023-06-09	2024-06-08
24	6dB Attenuator	/	100W/6dB	1172040	2023-06-09	2024-06-08
25	3dB Attenuator	/	2N-3dB	/	2023-10-18	2024-10-17





## 6. PHOTOGRAPHS OF TEST SETUP

Please refer to separated files Appendix D for Photographs of Test Setup\_RF.

## 7. PHOTOGRAPHS OF THE EUT

Please refer to separated files Appendix C for Photographs of The EUT.

-----THE END OF REPORT-----

