



RADIO TEST REPORT

For

Navori SA

Media Player

Test Model: Stix3800

Prepared for : Navori SA
Address : Avenue mon repos 22, 1005 lausanne, Switzerland

Prepared by : Shenzhen LCS Compliance Testing Laboratory Ltd.
Address : Room 101, 201, Building A and Room 301, Building C, Juji Industrial Park, Yabianxueziwei, Shajing Street, Bao'an District, Shenzhen, Guangdong, China

Tel : (+86)755-82591330
Fax : (+86)755-82591332
Web : www.LCS-cert.com
Mail : webmaster@LCS-cert.com

Date of receipt of test sample : April 07, 2024
Number of tested samples : 2
Sample No. : A240401010-1, A240401010-2
Serial number : Prototype
Date of Test : April 07, 2024 ~ April 22, 2024
Date of Report : April 22, 2024





RADIO TEST REPORT ETSI EN 300 328 V2.2.2 (2019-07)	
Wideband transmission systems; Data transmission equipment operating in the 2,4 GHz band; Harmonised Standard for access to radio spectrum	
Report Reference No.	: LCSA04014116ED
Date of Issue	: April 22, 2024
Testing Laboratory Name	: Shenzhen LCS Compliance Testing Laboratory Ltd.
Address	: Room 101, 201, Building A and Room 301, Building C, Juji Industrial Park, Yabianxueziwei, Shajing Street, Bao'an District, Shenzhen, Guangdong, China
Testing Location/ Procedure	: Full application of Harmonised standards <input checked="" type="checkbox"/> Partial application of Harmonised standards <input type="checkbox"/> Other standard testing method <input type="checkbox"/>
Applicant's Name	: Navori SA
Address	: Avenue mon repos 22, 1005 lausanne, Switzerland
Test Specification	
Standard	: ETSI EN 300 328 V2.2.2 (2019-07)
Test Report Form No.	: LCSEMC-1.0
TRF Originator	: Shenzhen LCS Compliance Testing Laboratory Ltd.
Master TRF	: Dated 2017-06
Shenzhen LCS Compliance Testing Laboratory Ltd. All rights reserved. This publication may be reproduced in whole or in part for non-commercial purposes as long as the Shenzhen LCS Compliance Testing Laboratory Ltd. is acknowledged as copyright owner and source of the material. Shenzhen LCS Compliance Testing Laboratory Ltd. takes no responsibility for and will not assume liability for damages resulting from the reader's interpretation of the reproduced material due to its placement and context.	
Test Item Description	: Media Player
Trade Mark	: Navori
Test Model	: Stix3800
Ratings	: Input: DC 5V, 2A
Result	: Positive

Compiled by:

Joker.Hu

Joker Hu/ Administrator

Supervised by:

Cary Luo

Cary Luo/ Technique principal

Approved by:

Gavin Liang

Gavin Liang/ Manager





RADIO -- TEST REPORT

Test Report No. : LCSA04014116ED	<u>April 22, 2024</u> Date of issue
---	--

Test Model..... : Stix3800 EUT..... : Media Player
Applicant..... : Navori SA Address..... : Avenue mon repos 22, 1005 lausanne, Switzerland Telephone..... : / Fax..... : /
Manufacturer..... : Shenzhen Geniatech INC., Ltd. Address..... Room 02-04, 10/F, Block A, Building 8, Shenzhen : International Innovation Valley, Dashi Road, Nanshan District, Shenzhen, Guangdong, China. Telephone..... : / Fax..... : /
Factory : Shenzhen Geniatech INC., Ltd. Address : 2F Block A, Yinghaosheng Industrial park,Fu'an Road,Dayang Development Zone,Fuyong Town, Bao'an District, Shenhen, China. Telephone..... : / Fax..... : /

Test Result	Positive
--------------------	-----------------

The test report merely corresponds to the test sample.
It is not permitted to copy extracts of these test result without the written permission of the test laboratory.





Revision History

Report Version	Issue Date	Revision Content	Revised By
000	April 22, 2024	Initial Issue	---



Shenzhen LCS Compliance Testing Laboratory Ltd.
Add: Room 101, 201, Building A and Room 301, Building C, Juji Industrial Park, Yabianxueziwei, Shajing Street,
Bao'an District, Shenzhen, Guangdong, China
Tel: +(86) 0755-82591330 | E-mail: webmaster@lcs-cert.com | Web: www.lcs-cert.com
Scan code to check authenticity



TABLE OF CONTENTS

- 1. GENERAL INFORMATION 6**
 - 1.1. PRODUCT DESCRIPTION FOR EQUIPMENT UNDER TEST (EUT) 6
 - 1.2. OBJECTIVE 12
 - 1.3. RELATED SUBMITTAL(S)/GRANT(S) 12
 - 1.4. TEST METHODOLOGY 12
 - 1.5. DESCRIPTION OF TEST FACILITY 12
 - 1.6. SUPPORT EQUIPMENT LIST 12
 - 1.8. MEASUREMENT UNCERTAINTY 13
 - 1.9. TEST ENVIRONMENT 13
 - 1.10. DESCRIPTION OF TEST MODES 13
- 2. SYSTEM TEST CONFIGURATION 14**
 - 2.1. JUSTIFICATION 14
 - 2.2. EUT EXERCISE SOFTWARE 14
 - 2.3. SPECIAL ACCESSORIES 14
 - 2.4. BLOCK DIAGRAM/SCHEMATICS 14
 - 2.5. EQUIPMENT MODIFICATIONS 14
 - 2.6. CONFIGURATION OF TEST SETUP 14
- 3. SUMMARY OF TEST RESULT 15**
- 4. TEST RESULTS 16**
 - 4.1. RF OUTPUT POWER 16
 - 4.2. POWER SPECTRAL DENSITY 18
 - 4.3. DUTY CYCLE, TX-SEQUENCE, TX-GAP 20
 - 4.4. MEDIUM UTILISATION (MU) FACTOR 21
 - 4.5. ADAPTIVITY 22
 - 4.6. OCCUPIED CHANNEL BANDWIDTH 24
 - 4.7. TRANSMITTER UNWANTED EMISSIONS IN THE OUT-OF-BAND DOMAIN 25
 - 4.8. TRANSMITTER UNWANTED EMISSIONS IN THE SPURIOUS DOMAIN 28
 - 4.9. RECEIVER SPURIOUS EMISSIONS 31
 - 4.10. RECEIVER BLOCKING 33
- 5. LIST OF MEASURING EQUIPMENT 36**
- 6. PHOTOGRAPHS OF TEST SETUP 37**
- 7. PHOTOGRAPHS OF THE EUT 37**





1. GENERAL INFORMATION

1.1. Product Description for Equipment Under Test (EUT)

EUT	: Media Player
Test Model	: Stix3800
Power Supply	: Input: DC 5V, 2A
Hardware Version	: RKN231219_V1.1
Software Version	: rk3568_r_0319
Bluetooth	:
Frequency Range	: 2402MHz ~ 2480MHz
Channel Number	: 79 channels for Bluetooth V5.0 (BDR/EDR) 40 channels for Bluetooth V5.0 (BT LE/BT 2LE)
Channel Spacing	: 1MHz for Bluetooth V5.0 (BDR/EDR) 2MHz for Bluetooth V5.0 (BT LE/BT 2LE)
Modulation Type	: GFSK, $\pi/4$ -DQPSK, 8-DPSK for Bluetooth V5.0 (BDR/EDR) GFSK for Bluetooth V5.0 (BT LE/BT 2LE)
Bluetooth Version	: V5.0
Antenna Description	: FPC Antenna, 1.99dBi(Max.)
WIFI(2.4G Band)	:
Frequency Range	: 2412MHz ~ 2472MHz
Channel Spacing	: 5MHz
Channel Number	: 13 Channel for 20MHz bandwidth(2412~2472MHz) 9 channels for 40MHz bandwidth(2422~2462MHz)
Modulation Type	: 802.11b: DSSS; 802.11g/n: OFDM
Antenna Description	: FPC Antenna, 1.99dBi(Max.)
WIFI(5.2G Band)	:
Frequency Range	: 5180MHz~5240MHz
Channel Number	: 4 channels for 20MHz bandwidth(5180~5240MHz) 2 channels for 40MHz bandwidth(5190~5230MHz) 1 channels for 80MHz bandwidth(5210MHz)
Modulation Type	: 802.11a/n: OFDM (64QAM, 16QAM, QPSK, BPSK) 802.11ac: OFDM (256QAM, 64QAM, 16QAM, QPSK, BPSK)
Antenna Description	: FPC Antenna, 2.46dBi(Max.)
WIFI(5.3G Band)	:
Frequency Range	: 5260MHz~5320MHz
Channel Number	: 4 Channels for 20MHz bandwidth(5260MHz~5320MHz) 2 channels for 40MHz bandwidth(5270MHz~5310MHz) 1 channels for 80MHz bandwidth(5290MHz)





Modulation Type : 802.11a/n: OFDM (64QAM, 16QAM, QPSK, BPSK)
 802.11ac: OFDM (256QAM, 64QAM, 16QAM, QPSK, BPSK)

Antenna Description : FPC Antenna, 2.46dBi(Max.)

WIFI(5.5G Band) :

Frequency Range : 5500MHz ~5700MHz

Channel Number : 11 Channels for 20MHz bandwidth(5500MHz~5700MHz)
 5 Channels for 40MHz bandwidth(5510MHz~5670MHz)
 2 Channels for 80MHz bandwidth(5530MHz~5610MHz)

Modulation Type : 802.11a/n: OFDM (64QAM, 16QAM, QPSK, BPSK)
 802.11ac: OFDM (256QAM, 64QAM, 16QAM, QPSK, BPSK)

Antenna Description : FPC Antenna, 2.46dBi(Max.)

WIFI(5.8G Band) :

Frequency Range : 5745MHz ~ 5825MHz

Channel Number : 5 channels for 20MHz bandwidth(5745~5825MHz)
 2 channels for 40MHz bandwidth(5755~5795MHz)
 1 channels for 80MHz bandwidth(5775MHz)

Modulation Type : 802.11a/n: OFDM (64QAM, 16QAM, QPSK, BPSK)
 802.11ac: OFDM (256QAM, 64QAM, 16QAM, QPSK, BPSK)

Antenna Description : FPC Antenna, 2.46dBi(Max.)





Product Information

a) The type of modulation used by the equipment:

- FHSS
- other forms of modulation

b) In case of FHSS modulation:

•In case of non-Adaptive Frequency Hopping equipment:

The number of Hopping Frequencies:

•In case of Adaptive Frequency Hopping Equipment:

The maximum number of Hopping Frequencies:

The minimum number of Hopping Frequencies:

The Dwell Time:

The Minimum Channel Occupation Time:

c) Adaptive / non-adaptive equipment:

- non-adaptive Equipment
- adaptive Equipment without the possibility to switch to a non-adaptive mode
- adaptive Equipment which can also operate in a non-adaptive mode

d) In case of adaptive equipment:

The Channel Occupancy Time implemented by the equipment:

The equipment has implemented an LBT based DAA mechanism

• In case of equipment using modulation different from FHSS:

The equipment is Frame Based equipment

The equipment is Load Based equipment

The equipment can switch dynamically between Frame Based and Load Based equipment

The CCA time implemented by the equipment:20µs

The value q as referred to in clause 4.3.2.5.2.2.2

The equipment has implemented an non-LBT based DAA mechanism

The equipment can operate in more than one adaptive mode

e) In case of non-adaptive Equipment:

The maximum RF Output Power (e.i.r.p.): 14.20dBm

The maximum (corresponding) Duty Cycle: 100 %

Equipment with dynamic behaviour, that behaviour is described here. (e.g. the different combinations of duty cycle and corresponding power levels to be declared):

f) The worst case operational mode for each of the following tests:

- RF Output Power
DSSS, OFDM
- Power Spectral Density
DSSS, OFDM
- Duty cycle, Tx-Sequence, Tx-gap





- Dwell time, Minimum Frequency Occupation & Hopping Sequence (only for FHSS equipment)

- Hopping Frequency Separation (only for FHSS equipment)

- Medium Utilisation

- Adaptivity & Receiver Blocking

DSSS, OFDM

- Occupied Channel Bandwidth

DSSS, OFDM

- Transmitter unwanted emissions in the OOB domain

DSSS, OFDM

- Transmitter unwanted emissions in the spurious domain

DSSS, OFDM

- Receiver spurious emissions

DSSS, OFDM

g) The different transmit operating modes (tick all that apply):

- Operating mode 1: Single Antenna Equipment
- Equipment with only 1 antenna
- Equipment with 2 diversity antennas but only 1 antenna active at any moment in time
- Smart Antenna Systems with 2 or more antennas, but operating in a (legacy) mode where only 1 antenna is used. (e.g. IEEE 802.11™ [i.3] legacy mode in smart antenna systems)
- Operating mode 2: Smart Antenna Systems - Multiple Antennas without beam forming
- Single spatial stream / Standard throughput / (e.g. IEEE 802.11™ [i.3] legacy mode)
- High Throughput (> 1 spatial stream) using Occupied Channel Bandwidth 1
- High Throughput (> 1 spatial stream) using Occupied Channel Bandwidth 2

NOTE: Add more lines if more channel bandwidths are supported.

- Operating mode 3: Smart Antenna Systems - Multiple Antennas with beam forming
- Single spatial stream / Standard throughput (e.g. IEEE 802.11™ [i.3] legacy mode)
- High Throughput (> 1 spatial stream) using Occupied Channel Bandwidth 1
- High Throughput (> 1 spatial stream) using Occupied Channel Bandwidth 2

NOTE: Add more lines if more channel bandwidths are supported.

h) In case of Smart Antenna Systems:

- The number of Receive chains:
- The number of Transmit chains:

- symmetrical power distribution
- asymmetrical power distribution

In case of beam forming, the maximum beam forming gain:

NOTE: Beam forming gain does not include the basic gain of a single antenna.

i) Operating Frequency Range(s) of the equipment:

- Operating Frequency Range 1: 2412MHz to 2472MHz





- Operating Frequency Range 2: 2422MHz to 2462MHz

NOTE: Add more lines if more Frequency Ranges are supported.

j) Occupied Channel Bandwidth(s):

- Occupied Channel Bandwidth 1: 17.691MHz
- Occupied Channel Bandwidth 2: 36.230MHz

NOTE: Add more lines if more channel bandwidths are supported.

k) Type of Equipment (stand-alone, combined, plug-in radio device, etc.):

- Stand-alone
- Combined Equipment (Equipment where the radio part is fully integrated within another type of equipment)
- Plug-in radio device (Equipment intended for a variety of host systems)
- Other

l) The extreme operating conditions that apply to the equipment:

- Operating temperature range: -20° C to 45° C
- Details provided are for the: stand-alone equipment
- combined (or host) equipment
- test jig

m) The intended combination(s) of the radio equipment power settings and one or more antenna assemblies and their corresponding e.i.r.p levels:

- Antenna Type
- FPC Antenna,
- Antenna Gain: 1.99dBi
- If applicable, additional beamforming gain (excluding basic antenna gain): dB
- Temporary RF connector provided
- No temporary RF connector provided
- Dedicated Antennas (equipment with antenna connector)
- Single power level with corresponding antenna(s)
- Multiple power settings and corresponding antenna(s)
- Number of different Power Levels:
- Power Level 1:dBm
- Power Level 2: dBm
- Power Level 3: dBm

NOTE 1: Add more lines in case the equipment has more power levels.
 NOTE 2: These power levels are conducted power levels (at antenna connector).

n) The nominal voltages of the stand-alone radio equipment or the nominal voltages of the combined (host) equipment or test jig in case of plug-in devices:

- Details provided are for the: stand-alone equipment
- combined (or host) equipment
- test jig
- Supply Voltage AC mains State AC voltage: 230V





DC State DC voltage: 5V

In case of DC, indicate the type of power source

- Internal Power Supply
- External Power Supply or AC/DC adapter
- Battery: V
- Other:

o) Describe the test modes available which can facilitate testing:

The EUT can transmit in engineering mode.

p) The equipment type (e.g. Bluetooth®, IEEE 802.11™ [i.3], proprietary, etc.):

IEEE 802.11™





1.2. Objective

This Type approval report is prepared on behalf of **Navori SA** in accordance with ETSI EN 300 328 V2.2.2 (2019-07), Wideband transmission systems; Data transmission equipment operating in the 2,4 GHz band; Harmonised Standard for access to radio spectrum.

The objective is to determine compliance with ETSI EN 300 328 V2.2.2 (2019-07).

1.3. Related Submittal(s)/Grant(s)

No Related Submittals.

1.4. Test Methodology

All measurements contained in this report were conducted with ETSI EN 300 328 V2.2.2 (2019-07).

1.5. Description of Test Facility

NVLAP Accreditation Code is 600167-0.

FCC Designation Number is CN5024.

CAB identifier is CN0071.

CNAS Registration Number is L4595.

1.6. Support Equipment List

Manufacturer	Description	Model	Serial Number	Certificate
Shenzhen Meike Star communication Technology Co., LTD	ADAPTER	M535122-2X1	---	CE
Lenovo	PC	TP00094A	---	CE

Note: PC is supplied by lab and only used test.

1.7. External I/O

I/O Port Description	Quantity	Cable
Type-C USB Port	1	N/A
USB Port	2	N/A
POE Port	2	N/A
HDMI Port	1	N/A
TF Card Port	1	N/A



Shenzhen LCS Compliance Testing Laboratory Ltd.

Add: Room 101, 201, Building A and Room 301, Building C, Juji Industrial Park, Yabianxueziwei, Shajing Street, Bao'an District, Shenzhen, Guangdong, China

Tel: +(86) 0755-82591330 | E-mail: webmaster@lcs-cert.com | Web: www.lcs-cert.com

Scan code to check authenticity



1.8. Measurement Uncertainty

Where relevant, the following measurement uncertainty levels have been estimated for tests performed on the apparatus:

Parameter	Uncertainty
Occupied Channel Bandwidth	5 %
RF output power, conducted	1,5 dB
Power Spectral Density, conducted	3 dB
Unwanted Emissions, conducted	3 dB
All emissions, radiated	6 dB
Temperature	1 °C
Humidity	5 %
DC and low frequency voltages	3 %
Time	5 %
Duty Cycle	5 %

1.9. Test Environment

Items	Required (IEC 68-1)	Actual
Temperature (°C)	15-35	23.3
Humidity (%RH)	25-75	53.6
Barometric pressure (mbar)	860-1060	950-1000

1.10. Description of Test Modes

LCS has verified the construction and function in typical operation. All the test modes were carried out with the EUT in normal operation, which was shown in this test report and defined as:

Test Mode
Mode 1: Transmit by 802.11b
Mode 2: Transmit by 802.11g
Mode 3: Transmit by 802.11n(20MHz)
Mode 4: Transmit by 802.11n(40MHz)
Mode 5: Receive by 802.11b
Mode 6: Receive by 802.11g
Mode 7: Receive by 802.11n(20MHz)
Mode 8: Receive by 802.11n(40MHz)

Note:

- (1) For portable device, radiated spurious emission was verified over X, Y, Z Axis, and shown the worst case on this report.
- (2) Regard to the frequency band operation for systems using Wide Band modulation: the lowest, middle, highest frequency channel for conducted test, and the lowest, highest frequency channel for radiation spurious test.
- (3) The extreme test condition for voltage and temperature were declared by the manufacturer.
- (4) All test modes were tested, but we only recorded the worst case in this report.





2. SYSTEM TEST CONFIGURATION

2.1. Justification

The system was configured for testing in engineering mode.

2.2. EUT Exercise Software

N/A.

2.3. Special Accessories

N/A.

2.4. Block Diagram/Schematics

Please refer to the related document.

2.5. Equipment Modifications

Shenzhen LCS Compliance Testing Laboratory Ltd. has not done any modification on the EUT.

2.6. Configuration of Test Setup

Please refer to the test setup photo.





3. SUMMARY OF TEST RESULT

- No deviations from the test standards
 Deviations from the test standards as below description:

Technical requirements for the equipment using wide band modulations other than FHSS:

Performed Test Item	Normative References	Test Performed	Deviation
RF Output Power & Receiver Category	ETSI EN 300 328 V2.2.2 (2019-07)	Yes	No
Power Spectral Density	ETSI EN 300 328 V2.2.2 (2019-07)	Yes	No
Duty cycle, Tx-Sequence, Tx-gap	ETSI EN 300 328 V2.2.2 (2019-07)	N/A	N/A
Medium Utilisation (MU) factor	ETSI EN 300 328 V2.2.2 (2019-07)	N/A	N/A
Adaptivity	ETSI EN 300 328 V2.2.2 (2019-07)	Yes	No
Occupied Channel Bandwidth	ETSI EN 300 328 V2.2.2 (2019-07)	Yes	No
Transmitter unwanted emissions in the out-of-band domain	ETSI EN 300 328 V2.2.2 (2019-07)	Yes	No
Transmitter unwanted emissions in the spurious domain	ETSI EN 300 328 V2.2.2 (2019-07)	Yes	No
Receiver Spurious Emissions	ETSI EN 300 328 V2.2.2 (2019-07)	Yes	No
Receiver Blocking	ETSI EN 300 328 V2.2.2 (2019-07)	Yes	No

Note:

- The EUT can operate in an adaptive mode, and can't operate in a non-adaptive mode which is stated by the supplier.
- The EUT is equipment which using wide band modulations other than FHSS. It is an adaptive equipment which can't operate in non-adaptive mode.





4. TEST RESULTS

4.1. RF Output Power

4.1.1 Limit

For adaptive equipment using wide band modulations other than FHSS, the maximum RF output power shall be 20 dBm.

The maximum RF output power for non-adaptive equipment shall be declared by the supplier and shall not exceed 20 dBm. For non-adaptive equipment using wide band modulations other than FHSS, the maximum RF output power shall be equal to or less than the value declared by the supplier.

This limit shall apply for any combination of power level and intended antenna assembly.

4.1.2 Test Setup

For Conducted Measurement

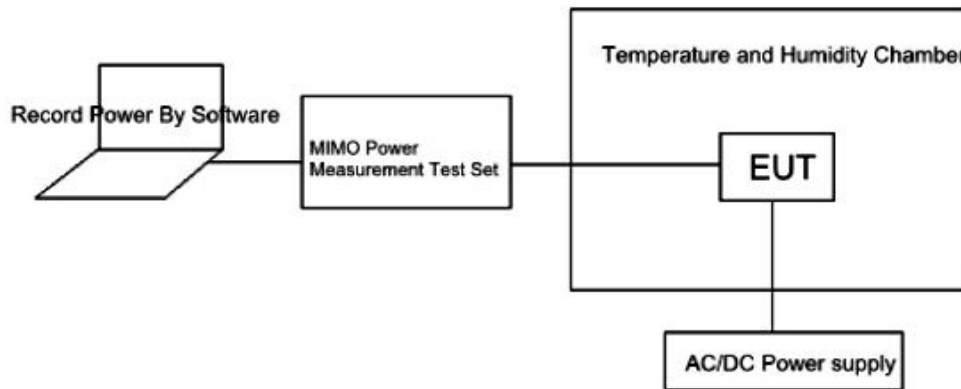



4.1.3 Test Procedure

Refer to ETSI EN 300 328 V2.2.2 (2019-07) Clause 5.4.2

Step 1:

- The fast power sensor use the following setting: Sample speed 1 MS/s.

Step 2:

- Connect the power sensor to the transmit port, sample the transmit signal and store the raw data. Use these stored samples in all following steps.

Step 3:

- Find the start and stop times of each burst in the stored measurement samples.

Step 4:

- Between the start and stop times of each individual burst calculate the RMS power over the burst. Save these Pburst values, as well as the start and stop times for each burst.

Step 5:

- The highest of all Pburst values (value "A" in dBm) will be used for maximum e.i.r.p. calculations.

Step 6:

- Add the (stated) antenna assembly gain "G" in dBi of the individual antenna.
- If applicable, add the additional beamforming gain "Y" in dB.

The RF Output Power (P) shall be calculated using the formula below:

$$P = A + G + Y$$

4.1.4 Test Result

Please refer to the Appendix G.1 for 2.4G WIFI RF Test Data.

4.1.5 Receiver Category

Receiver Category 1: Adaptive equipment with a maximum RF output power greater than 10 dBm e.i.r.p. shall be considered as receiver category 1 equipment.

Receiver Category 2: Non-adaptive equipment with a Medium Utilization (MU) factor greater than 1 % and less than or equal to 10 % or equipment (adaptive or non-adaptive) with a maximum RF output power greater than 0 dBm e.i.r.p. and less than or equal to 10 dBm e.i.r.p. shall be considered as receiver category 2 equipment.

Receiver Category 3: Non-adaptive equipment with a maximum Medium Utilization (MU) factor of 1 % or equipment (adaptive or non-adaptive) with a maximum RF output power of 0 dBm e.i.r.p. shall be considered as receiver category 3 equipment.

As this an adaptivity device with a maximum power of 14.20dBm, **it belongs to receiver category 1.**



Shenzhen LCS Compliance Testing Laboratory Ltd.

Add: Room 101, 201, Building A and Room 301, Building C, Juji Industrial Park, Yabianxueziwei, Shajing Street, Bao'an District, Shenzhen, Guangdong, China

Tel: +(86) 0755-82591330 | E-mail: webmaster@lcs-cert.com | Web: www.lcs-cert.com

Scan code to check authenticity

4.2. Power Spectral Density

4.2.1 Limit

For equipment using wide band modulations other than FHSS, the maximum Power Spectral Density is limited to 10dBm per MHz.

4.2.2 Test Setup

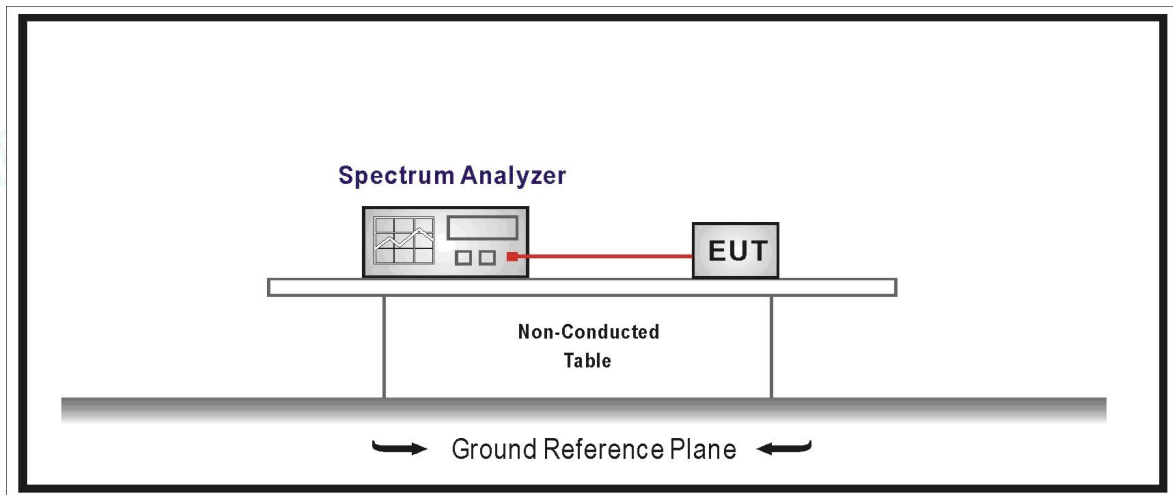

4.2.3 Test Procedure

Refer to ETSI EN 300 328 V2.2.2 (2019-07) Clause 5.4.3

Step 1:

Connect the UUT to the spectrum analyzer and use the following settings:

- Start Frequency: 2 400 MHz
- Stop Frequency: 2 483,5 MHz
- Resolution BW: 10 kHz
- Video BW: 30 kHz
- Sweep Points: > 8 350
- Detector: RMS
- Trace Mode: Max Hold
- Sweep time: Auto

For non-continuous signals, wait for the trace to be completed. Save the (trace) data set to a file.

Step 2:

For each frequency point, add up the amplitude (power) values for the different transmit chains and use this as the new data set.

Step 3:

Add up the values for amplitude (power) for all the samples in the file.



**Step 4:**

Normalize the individual values for amplitude so that the sum is equal to the RF Output Power (e.i.r.p.).

Step 5:

Starting from the first sample in the file (lowest frequency), add up the power of the following samples representing a 1 MHz segment and record the results for power and position (i.e. sample #1 to #100). This is the Power Spectral Density (e.i.r.p.) for the first 1 MHz segment which shall be recorded.

Step 6:

Shift the start point of the samples added up in step 5 by 1 sample and repeat the procedure in step 5 (i.e. sample #2 to #101).

Step 7:

Repeat step 6 until the end of the data set and record the radiated Power Spectral Density values for each of the 1 MHz segments. From all the recorded results, the highest value is the maximum Power Spectral Density for the UUT.

4.2.4 Test Result

Please refer to the Appendix G.2 for 2.4G WIFI RF Test Data.



4.3. Duty Cycle, TX-Sequence, TX-Gap

4.3.1 Limit

The Duty Cycle shall be equal to or less than the maximum value declared by the supplier. The maximum Tx-sequence Time and the minimum Tx-gap Time shall be according to the formula below: Maximum Tx-Sequence Time = Minimum Tx-gap Time = M where M is in the range of 3,5 ms to 10 ms.

4.3.2 Test Setup

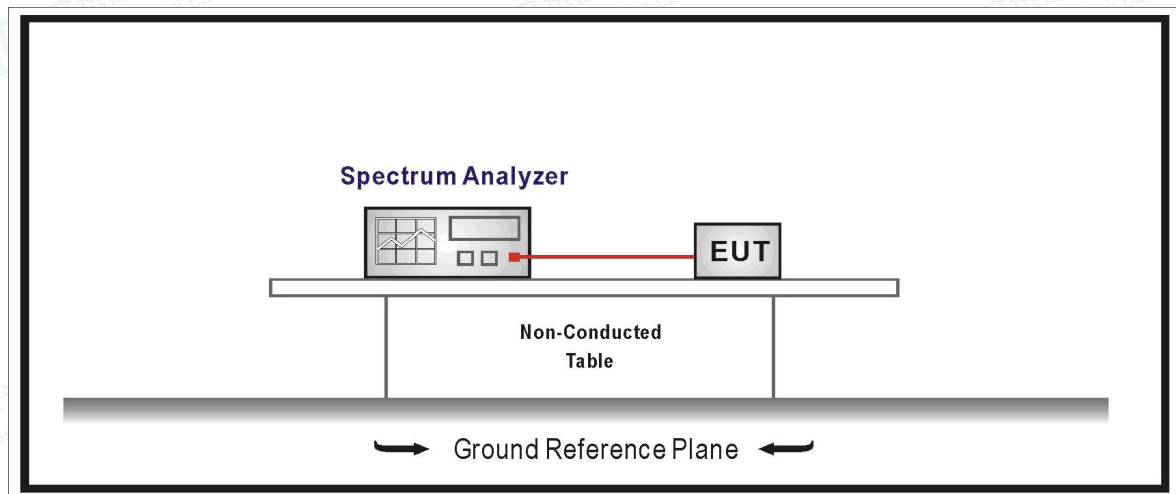

4.3.3 Test Procedure

Refer to ETSI EN 300 328 V2.2.2 (2019-07) Clause 5.4.2

4.3.4 Test Result

These requirements apply to non-adaptive frequency hopping equipment or to adaptive frequency hopping equipment operating in a non-adaptive mode.

These requirements do not apply for equipment with a maximum declared RF Output power of less than 10dBm E.I.R.P. or for equipment when operating in a mode where the RF Output power is less than 10dBm E.I.R.P.

No applicable.



4.4. Medium Utilisation (MU) Factor

4.4.1 Limit

For non-adaptive equipment

The maximum Medium Utilisation factor for non-adaptive Frequency Hopping equipment shall be 10 %.

4.4.2 Test Setup

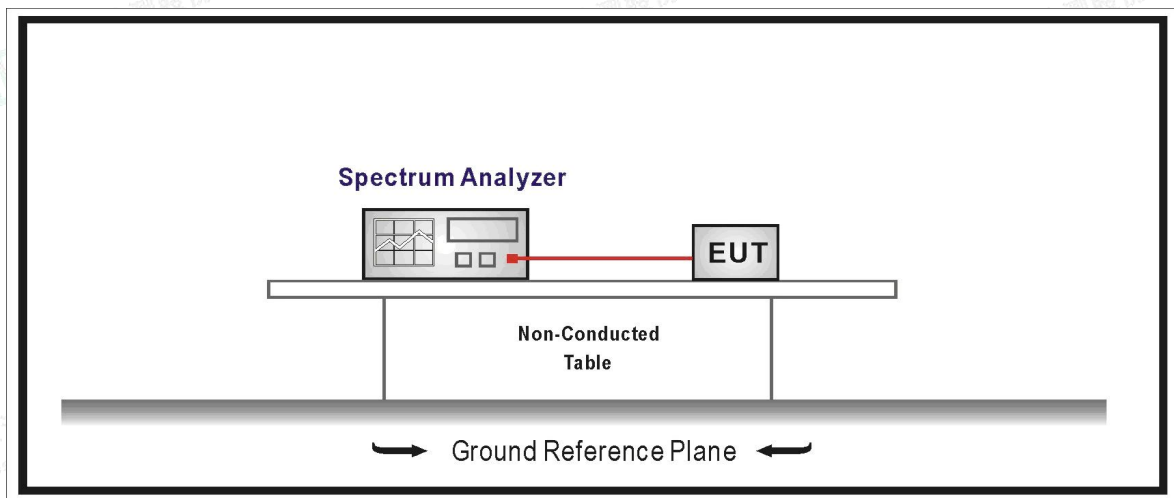

4.4.3 Test Procedure

Refer to ETSI EN 300 328 V2.2.2 (2019-07) Clause 5.4.2

4.4.4 Test Result

This requirement does not apply to adaptive equipment unless operating in a non-adaptive mode.

In addition, this requirement does not apply for equipment with a maximum declared RF Output power level of less than 10dBm E.I.R.P. or for equipment when operating in a mode where the RF Output power is less than 10dBm E.I.R.P.

No applicable.





4.5. Adaptivity

4.5.1 Limit

Adaptivity Limit	
<input type="checkbox"/>	<p>Non-LBT based Detect and Avoid</p> <p>--- The channel shall remain unavailable for a minimum time equal to 1 s after which the channel may be considered again as an 'available' channel;</p> <p>--- COT \leq 40 ms;</p> <p>--- COT \leq 60 ms;</p> <p>--- Idle Period shall be minimum 5% of COT with a minimum of 100us;</p> <p>--- Detection threshold level = -70dBm/MHz + 20 – Pout E.I.R.P (Pout in dBm);</p>
<input type="checkbox"/>	<p>LBT based Detect and Avoid(Frame Based Equipment)</p> <p>--- The CCA observation time shall be not less than 20 us;</p> <p>--- The CCA time used by the equipment shall be declared by the supplier;</p> <p>--- COT = 1-10 ms;</p> <p>--- Idle Period = 5% of COT;</p> <p>--- Detection threshold level = -70dBm/MHz + 20 – Pout E.I.R.P (Pout in dBm);</p>
<input checked="" type="checkbox"/>	<p>LBT based Detect and Avoid(Load Based Equipment)</p> <p>--- The CCA observation time shall be not less than 20 us;</p> <p>--- The CCA time used by the equipment shall be declared by the supplier;</p> <p>--- COT \leq (13 / 32) * q ms; q = [4~32]; 1.625ms~13ms;</p> <p>--- R = number of clear idle slots are randomly [1~q]. Every time an Extended CCA is required and the 'R' value stored in a counter.</p> <p>--- Detection threshold level = -70dBm/MHz + 20 – Pout E.I.R.P (Pout in dBm);</p>
<input type="checkbox"/>	<p>Short Control Signalling Transmissions:</p> <p>--- Short Control Signalling Transmissions shall have a maximum duty cycle of 10% within an observation period of 50ms.</p>



4.5.2 Test Setup

Conducted measurements

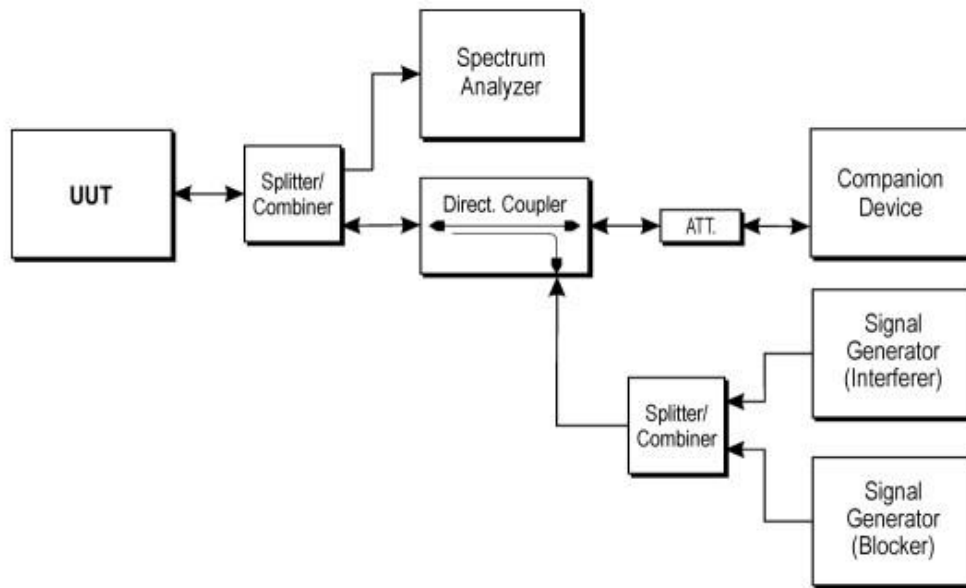

4.5.3 Test Procedure

Refer to ETSI EN 300 328 V2.2.2 (2019-07) Clause 5.4.6

- 1) The EUT connect to a companion device during the test. Adjust the received signal level at the EUT to the value defined in table 6 of ETSI EN 300 328 V2.2.2 Clause 4.3.2.10.2
- 2) the analyzer shall be set as below: RBW=8MHz and VBW=28MHz.
- 3) Configure the EUT for normal transmission with a sufficiently high payload to allow demonstration of compliance of the adaptive mechanism on the channel being tested.
- 4) Adding the interference signal and blocking signal.
- 5) Record the data.

4.5.4 Test Result

Please refer to the Appendix G.3 for 2.4G WIFI RF Test Data.



4.6. Occupied Channel Bandwidth

4.6.1 Limit

The Occupied Channel Bandwidth shall fall completely within the band given in 2.4GHz to 2.4835GHz.

In addition, for non-adaptive systems using wide band modulations other than FHSS and with e.i.r.p greater than 10 dBm, the occupied channel bandwidth shall be less than 20 MHz.

4.6.2 Test Setup

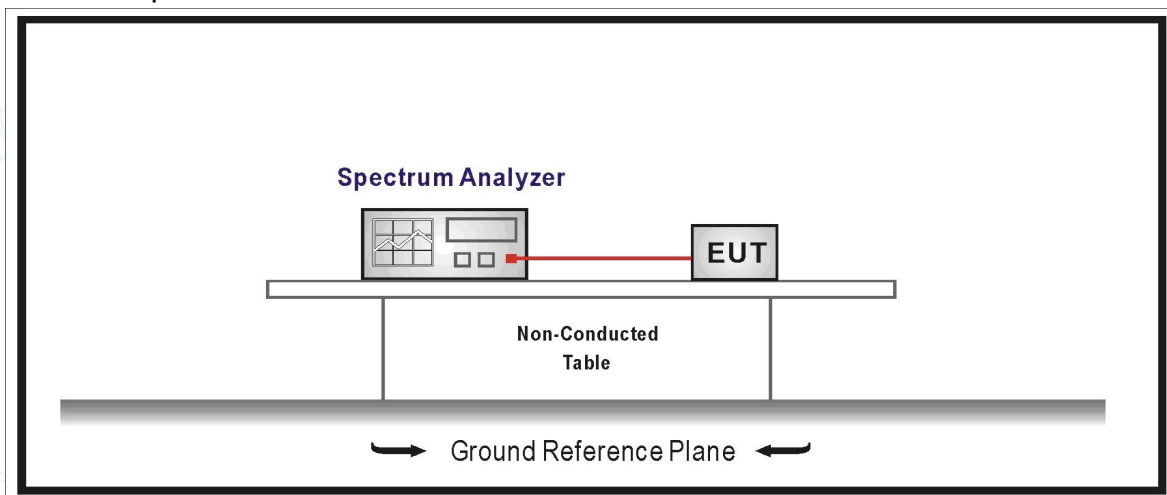

4.6.3 Test Procedure

Refer to ETSI EN 300 328 V2.2.2 (2019-07) Clause 5.4.7

Step 1:

Connect the UUT to the spectrum analyzer and use the following settings:

- Centre Frequency: The centre frequency of the channel under test
- Resolution BW: $\sim 1\%$ of the span without going below 1%
(we set RBW=400KHz for 802.11b/g/n20 and 820KHz for 802.11n40)
- Video BW: $3 \times$ RBW (we set VBW=1.2MHz for 802.11b/g/n20 and 2.4MHz for 802.11n40)
- Frequency Span: $2 \times$ Occupied Channel Bandwidth
(we set Span=40MHz(for 802.11b/g/n20) & 80MHz(for 802.11n40))
- Detector Mode: RMS
- Trace Mode: Max Hold

Step 2:

Wait until the trace is completed. Find the peak value of the trace and place the analyzer marker on this peak.

Step 3:

Use the 99 % bandwidth function of the spectrum analyzer to measure the Occupied Channel Bandwidth of the UUT. This value shall be recorded.

4.6.4 Test Result

Please refer to the Appendix G.4 for 2.4G WIFI RF Test Data.



4.7. Transmitter Unwanted Emissions in the Out-of-band Domain

4.7.1 Limit

The transmitter unwanted emissions in the out-of-band domain but outside the allocated band, shall not exceed the values provided by the mask in figure 3.

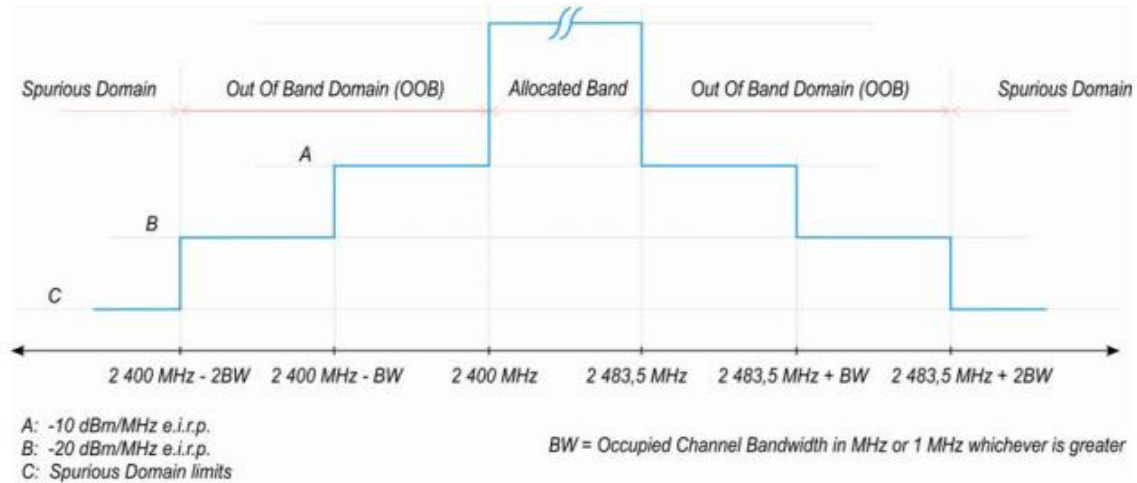
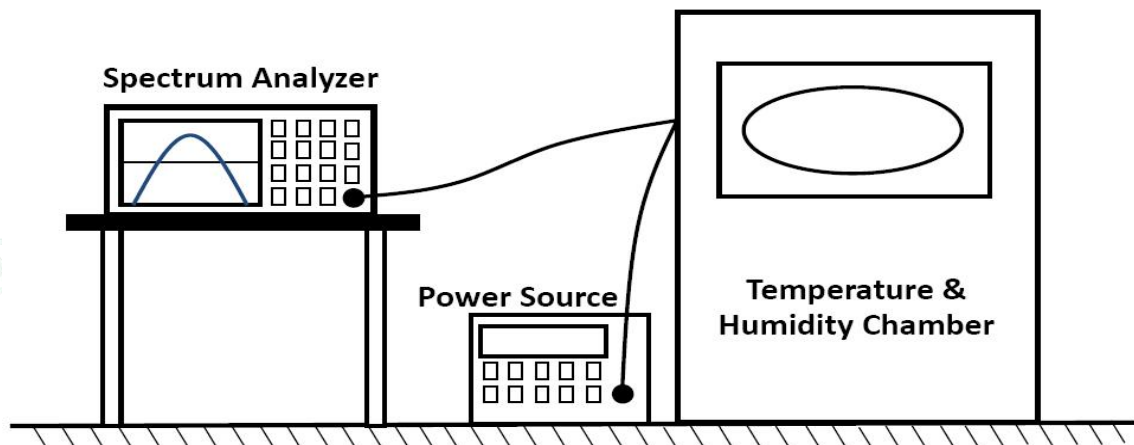

Figure 3: Transmit mask

4.7.2 Test Setup

For Conducted Measurement





4.7.3 Test Procedure

Refer to ETSI EN 300 328 V2.2.2 (2019-07) Clause 5.4.8

Step 1:

- Connect the UUT to the spectrum analyzer and use the following settings:
 - Centre Frequency: 2 484 MHz
 - Span: 0 Hz
 - Resolution BW: 1 MHz
 - Filter mode: Channel filter
 - Video BW: 3 MHz
 - Detector Mode: RMS
 - Trace Mode: Clear / Write
 - Sweep Mode: Continuous
 - Sweep Points: 5 000
 - Trigger Mode: Video trigger

NOTE 1: In case video triggering is not possible, an external trigger source may be used.

- Sweep Time: Suitable to capture one transmission burst

Step 2: (segment 2 483,5 MHz to 2 483,5 MHz + BW)

- Adjust the trigger level to select the transmissions with the highest power level.
- For frequency hopping equipment operating in a normal hopping mode, the different hops will result in signal bursts with different power levels. In this case the burst with the highest power level shall be selected.
- Set a window (start and stop lines) to match with the start and end of the burst and in which the RMS power shall be measured using the Time Domain Power function.
- Select RMS power to be measured within the selected window and note the result which is the RMS power within this 1 MHz segment (2 483,5 MHz to 2 484,5 MHz). Compare this value with the applicable limit provided by the mask.
- Increase the centre frequency in steps of 1 MHz and repeat this measurement for every 1 MHz segment within the range 2 483,5 MHz to 2 483,5 MHz + BW. The centre frequency of the last 1 MHz segment shall be set to 2 483,5 MHz + BW - 0,5 MHz (which means this may partly overlap with the previous 1 MHz segment).

Step 3: (segment 2 483,5 MHz + BW to 2 483,5 MHz + 2BW)

- Change the centre frequency of the analyzer to 2 484 MHz + BW and perform the measurement for the first 1 MHz segment within range 2 483,5 MHz + BW to 2 483,5 MHz + 2BW. Increase the centre frequency in 1 MHz steps and repeat the measurements to cover this whole range. The centre frequency of the last 1 MHz segment shall be set to 2 483,5 MHz + 2 BW - 0,5 MHz.

Step 4: (segment 2 400 MHz - BW to 2 400 MHz)

- Change the centre frequency of the analyzer to 2 399,5 MHz and perform the measurement for the first 1 MHz segment within range 2 400 MHz - BW to 2 400 MHz Reduce the centre





frequency in 1 MHz steps and repeat the measurements to cover this whole range. The centre frequency of the last 1 MHz segment shall be set to $2\,400\text{ MHz} - 2\text{BW} + 0,5\text{ MHz}$.

Step 5: (segment $2\,400\text{ MHz} - 2\text{BW}$ to $2\,400\text{ MHz} - \text{BW}$)

- Change the centre frequency of the analyzer to $2\,399,5\text{ MHz} - \text{BW}$ and perform the measurement for the first 1 MHz segment within range $2\,400\text{ MHz} - 2\text{BW}$ to $2\,400\text{ MHz} - \text{BW}$. Reduce the centre frequency in 1 MHz steps and repeat the measurements to cover this whole range. The centre frequency of the last 1 MHz segment shall be set to $2\,400\text{ MHz} - 2\text{BW} + 0,5\text{ MHz}$.

Step 6:

- In case of conducted measurements on equipment with a single transmit chain, the declared antenna assembly gain "G" in dBi shall be added to the results for each of the 1 MHz segments and compared with the limits provided by the mask given in figures 1 or 3. If more than one antenna assembly is intended for this power setting, the antenna with the highest gain shall be considered.
- In case of conducted measurements on smart antenna systems (equipment with multiple transmit chains), the measurements need to be repeated for each of the active transmit chains. The declared antenna assembly gain "G" in dBi for a single antenna shall be added to these results. If more than one antenna assembly is intended for this power setting, the antenna with the highest gain shall be considered. Comparison with the applicable limits shall be done using any of the options given below:

- Option 1: the results for each of the transmit chains for the corresponding 1 MHz segments shall be

added. The additional beamforming gain "Y" in dB shall be added as well and the resulting values

compared with the limits provided by the mask given in figures 1 or 3.

- Option 2: the limits provided by the mask given in figures 1 or 3 shall be reduced by $10 \times \log_{10}(\text{Ach})$ and the additional beamforming gain "Y" in dB. The results for each of the transmit chains shall be

individually compared with these reduced limits.

NOTE 2: Ach refers to the number of active transmit chains.

It shall be recorded whether the equipment complies with the mask provided in figures 1 or 3.

4.7.4 Test Result

Please refer to the Appendix G.5 for 2.4G WIFI RF Test Data.



4.8. Transmitter Unwanted Emissions in the Spurious Domain

4.8.1 Limit

Transmitter Limits for Spurious Emissions		
Frequency Range	Maximum power E.R.P. ($\leq 1\text{GHz}$) E.I.R.P. ($> 1\text{GHz}$)	Bandwidth
30 MHz to 47 MHz	-36 dBm	100 kHz
47 MHz to 74 MHz	-54 dBm	100 kHz
74 MHz to 87,5 MHz	-36 dBm	100 kHz
87,5 MHz to 118 MHz	-54 dBm	100 kHz
118 MHz to 174 MHz	-36 dBm	100 kHz
174 MHz to 230 MHz	-54 dBm	100 kHz
230 MHz to 470 MHz	-36 dBm	100 kHz
470 MHz to 694 MHz	-54 dBm	100 kHz
694 MHz to 1 GHz	-36 dBm	100 kHz
1 GHz to 12,75 GHz	-30 dBm	1 MHz

4.8.2 Test Setup

For Radiated Measurement

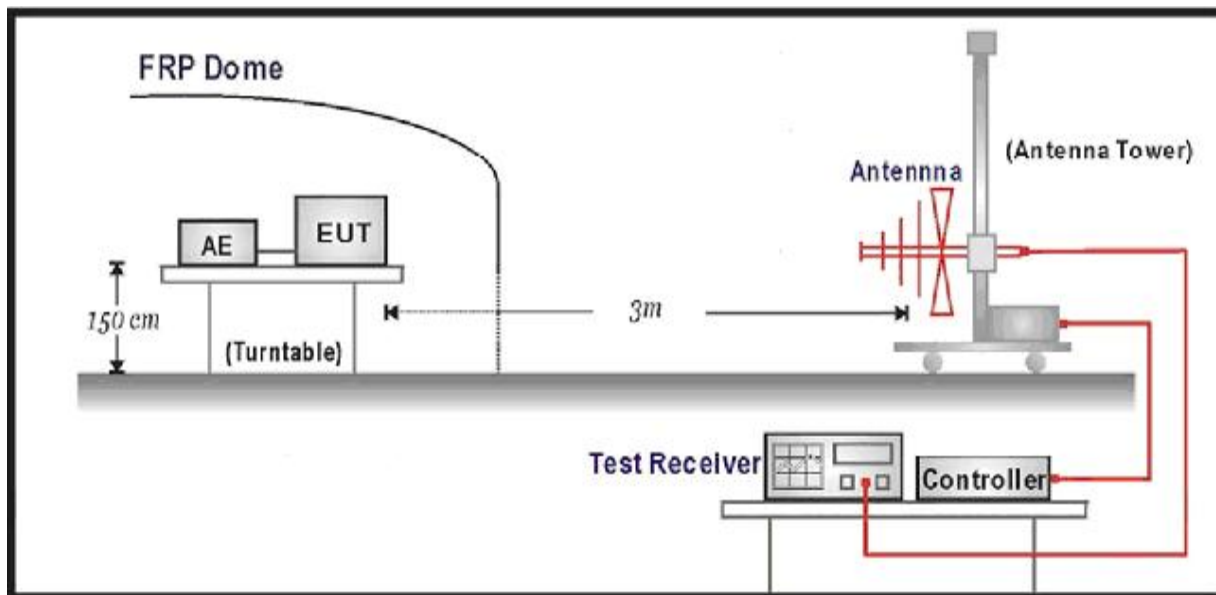

For Conducted Measurement

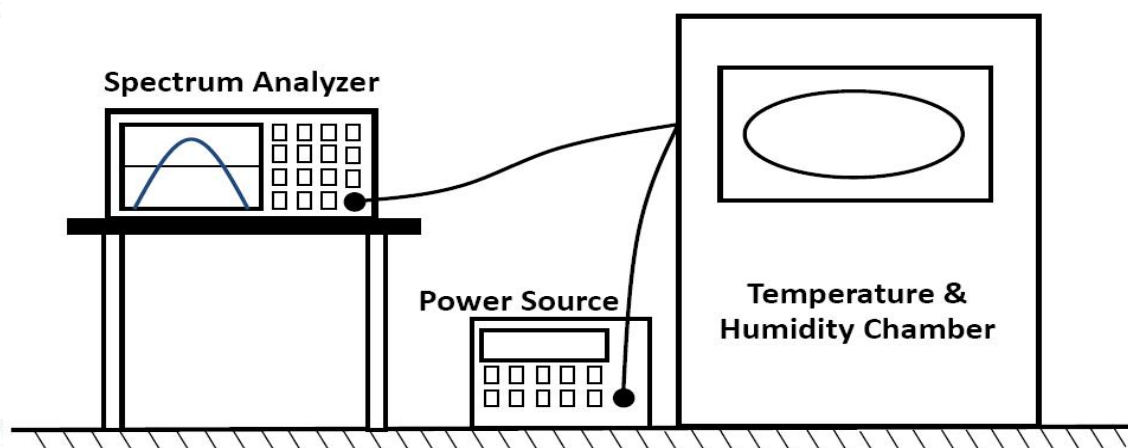

4.8.3 Test Procedure

Refer to ETSI EN 300 328 V2.2.2 (2019-07) Clause 5.4.9

Step 1:

The sensitivity of the spectrum analyzer should be such that the noise floor is at least 12 dB below the limits given in tables 1 or 4.

Step 2:

The emissions over the range 30 MHz to 1 000 MHz shall be identified.

Spectrum analyzer settings:

- Resolution bandwidth: 100 kHz
- Video bandwidth: 300 kHz
- Detector mode: Peak
- Trace Mode: Max Hold
- Sweep Points: $\geq 9\ 970$

NOTE 1: For spectrum analyzers not supporting this high number of sweep points, the frequency band may need to be segmented.

• Sweep time: For non continuous transmissions (duty cycle less than 100 %), the sweep time shall be sufficiently long, such that for each 100 kHz frequency step, the measurement time is greater than two transmissions of the UUT. For Frequency Hopping equipment operating in a normal operating (hopping not disabled) mode, the sweep time shall be further increased to capture multiple transmissions on the same hopping frequency in different hopping sequences. Allow the trace to stabilize. Any emissions identified during the sweeps above and that fall within the 6 dB range below the applicable limit or above, shall be individually measured using the procedure in clause 5.3.10.2.1.2 and compared to the limits given in tables 1 or 4.

Step 3:

The emissions over the range 1 GHz to 12,75 GHz shall be identified.

Spectrum analyzer settings:

- Resolution bandwidth: 1 MHz





- Video bandwidth: 3 MHz
- Detector mode: Peak
- Trace Mode: Max Hold
- Sweep Points: $\geq 11\ 750$

NOTE 2: For spectrum analyzers not supporting this high number of sweep points, the frequency band may need to be segmented.

- Sweep time: For non continuous transmissions (duty cycle less than 100 %), the sweep time shall be sufficiently long, such that for each 1 MHz frequency step, the measurement time is greater than two transmissions of the UUT.

4.8.4 Test Result

Please refer to the Appendix G.6 for 2.4G WIFI RF Test Data.



4.9. Receiver Spurious Emissions

4.9.1 Limit

Spurious emissions limits for receivers		
Frequency Range	Maximum power E.R.P. ($\leq 1\text{GHz}$) E.I.R.P. ($> 1\text{GHz}$)	Measurement bandwidth
30 MHz to 1 GHz	-57 dBm	100 kHz
1 GHz to 12.75 GHz	-47 dBm	1 MHz

4.9.2 Test Setup

For Radiated Measurement

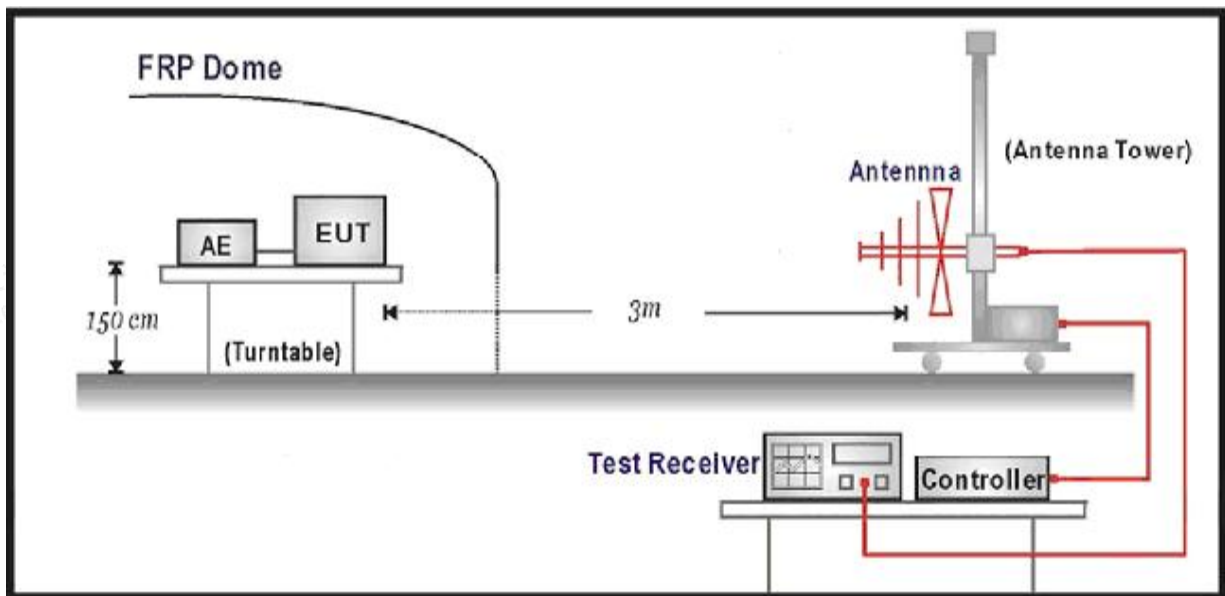

For Conducted Measurement

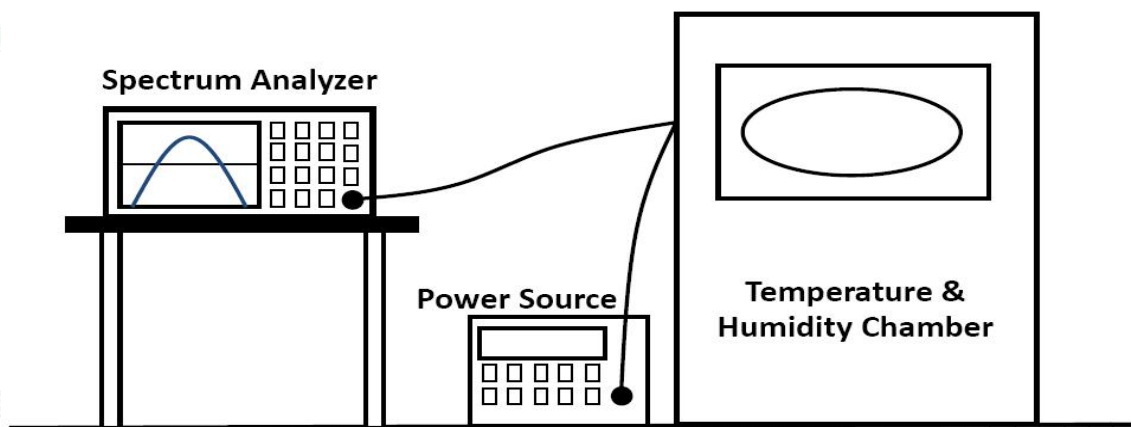



4.9.3 Test Procedure

Refer to ETSI EN 300 328 V2.2.2 (2019-07) Clause 5.4.10

Step 1:

The sensitivity of the spectrum analyzer should be such that the noise floor is at least 12 dB below the limits given in tables 2 or 5.

Step 2:

The emissions over the range 30 MHz to 1 000 MHz shall be identified.

Spectrum analyzer settings:

- Resolution bandwidth: 100 kHz
- Video bandwidth: 300 kHz
- Detector mode: Peak
- Trace Mode: Max Hold
- Sweep Points: $\geq 9\ 970$
- Sweep time: Auto

Allow the trace to stabilize. Any emissions identified during the sweeps above and that fall within the 6 dB range below the applicable limit or above, shall be individually measured using the procedure in clause 5.3.11.2.1.2 and compared to the limits given in tables 2 or 5.

Step 3:

The emissions over the range 1 GHz to 12,75 GHz shall be identified.

Spectrum analyzer settings:

- Resolution bandwidth: 1 MHz
- Video bandwidth: 3 MHz
- Detector mode: Peak
- Trace Mode: Max Hold
- Sweep Points: $\geq 11\ 750$
- Sweep time: Auto

Allow the trace to stabilize. Any emissions identified during the sweeps above that fall within the 6 dB range below the applicable limit or above, shall be individually measured using the procedure in clause 5.3.11.2.1.2 and compared to the limits given in tables 2 or 5. Frequency Hopping equipment may generate a block (or several blocks) of spurious emissions anywhere within the spurious domain. If this is the case, only the highest peak of each block of emissions shall be measured using the procedure in clause 5.3.11.2.1.2.

Step 4:

- In case of conducted measurements on smart antenna systems (equipment with multiple receive chains), the steps 2 and 3 need to be repeated for each of the active receive chains (Ach). The limits used to identify emissions during this pre-scan need to be reduced with $10 \times \log_{10}(\text{Ach})$ (number of active receive chains).

4.9.4 Test Result

Please refer to the Appendix G.7 for 2.4G WIFI RF Test Data.



Shenzhen LCS Compliance Testing Laboratory Ltd.

Add: Room 101, 201, Building A and Room 301, Building C, Juji Industrial Park, Yabianxueziwei, Shajing Street, Bao'an District, Shenzhen, Guangdong, China

Tel: +(86) 0755-82591330 | E-mail: webmaster@lcs-cert.com | Web: www.lcs-cert.com

Scan code to check authenticity



4.10. Receiver Blocking

4.10.1 Limit

Equipment shall comply with the requirements defined in clause 4.3.1.12.4

Table 6: Receiver Blocking parameters for Receiver Category 1 equipment

Wanted signal mean power from companion device (dBm) (see notes 1 and 4)	Blocking signal frequency (MHz)	Blocking signal power (dBm) (see note 4)	Type of blocking signal
$(-133 \text{ dBm} + 10 \times \log_{10}(\text{OCBW}))$ or -68 dBm whichever is less (see note 2)	2 380 2 504	-34	CW
$(-139 \text{ dBm} + 10 \times \log_{10}(\text{OCBW}))$ or -74 dBm whichever is less (see note 3)	2 300 2 330 2 360 2 524 2 584 2 674		
NOTE 1: OCBW is in Hz.			
NOTE 2: In case of radiated measurements using a companion device and the level of the wanted signal from the companion device cannot be determined, a relative test may be performed using a wanted signal up to $P_{\min} + 26 \text{ dB}$ where P_{\min} is the minimum level of wanted signal required to meet the minimum performance criteria as defined in clause 4.3.1.12.3 in the absence of any blocking signal.			
NOTE 3: In case of radiated measurements using a companion device and the level of the wanted signal from the companion device cannot be determined, a relative test may be performed using a wanted signal up to $P_{\min} + 20 \text{ dB}$ where P_{\min} is the minimum level of wanted signal required to meet the minimum performance criteria as defined in clause 4.3.1.12.3 in the absence of any blocking signal.			
NOTE 4: The level specified is the level at the UUT receiver input assuming a 0 dBi antenna assembly gain. In case of conducted measurements, this level has to be corrected for the (in-band) antenna assembly gain (G). In case of radiated measurements, this level is equivalent to a power flux density (PFD) in front of the UUT antenna with the UUT being configured/positioned as recorded in clause 5.4.3.2.2.			

Table 7: Receiver Blocking parameters receiver Category 2 equipment

Wanted signal mean power from companion device (dBm) (see notes 1 and 3)	Blocking signal frequency (MHz)	Blocking signal power (dBm) (see note 3)	Type of blocking signal
$(-139 \text{ dBm} + 10 \times \log_{10}(\text{OCBW}) + 10 \text{ dB})$ or $(-74 \text{ dBm} + 10 \text{ dB})$ whichever is less (see note 2)	2 380 2 504 2 300 2 584	-34	CW
NOTE 1: OCBW is in Hz.			
NOTE 2: In case of radiated measurements using a companion device and the level of the wanted signal from the companion device cannot be determined, a relative test may be performed using a wanted signal up to $P_{\min} + 26 \text{ dB}$ where P_{\min} is the minimum level of wanted signal required to meet the minimum performance criteria as defined in clause 4.3.1.12.3 in the absence of any blocking signal.			
NOTE 3: The level specified is the level at the UUT receiver input assuming a 0 dBi antenna assembly gain. In case of conducted measurements, this level has to be corrected for the (in-band) antenna assembly gain (G). In case of radiated measurements, this level is equivalent to a power flux density (PFD) in front of the UUT antenna with the UUT being configured/positioned as recorded in clause 5.4.3.2.2.			

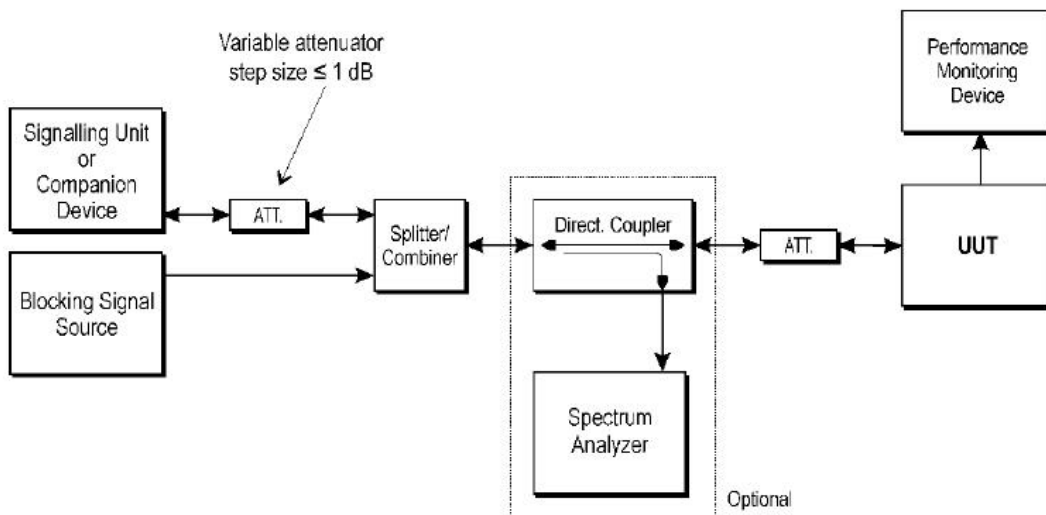

Table 8: Receiver Blocking parameters receiver Category 3 equipment

Wanted signal mean power from companion device (dBm) (see notes 1 and 3)	Blocking signal frequency (MHz)	Blocking signal power (dBm) (see note 3)	Type of blocking signal
(-139 dBm + 10 × log ₁₀ (OCBW) + 20 dB) or (-74 dBm + 20 dB) whichever is less (see note 2)	2 380 2 504 2 300 2 584	-34	CW
<p>NOTE 1: OCBW is in Hz.</p> <p>NOTE 2: In case of radiated measurements using a companion device and the level of the wanted signal from the companion device cannot be determined, a relative test may be performed using a wanted signal up to $P_{min} + 30$ dB where P_{min} is the minimum level of wanted signal required to meet the minimum performance criteria as defined in clause 4.3.1.12.3 in the absence of any blocking signal.</p> <p>NOTE 3: The level specified is the level at the UUT receiver input assuming a 0 dBi antenna assembly gain. In case of conducted measurements, this level has to be corrected for the (in-band) antenna assembly gain (G). In case of radiated measurements, this level is equivalent to a power flux density (PFD) in front of the UUT antenna with the UUT being configured/positioned as recorded in clause 5.4.3.2.2.</p>			

4.10.2 Test Setup

Conducted measurements



4.10.3 Test Procedure

Step 1:

- For non-frequency hopping equipment, the UUT shall be set to the lowest operating channel.

Step 2:

- The blocking signal generator is set to the first frequency as defined in the appropriate table corresponding to the receiver category and type of equipment.

Step 3:

- With the blocking signal generator switched off, a communication link is established between the UUT and the associated companion device using the test setup shown in figure 6. The attenuation of the variable attenuator shall be increased in 1 dB steps to a value at which the minimum performance criteria as specified in clause 4.3.1.12.3 or clause 4.3.2.11.3 is still met.





The resulting level for the wanted signal at the input of the UUT is Pmin.

- This signal level (Pmin) is increased by the value provided in the table corresponding to the receiver category and type of equipment.

Step 4:

- The blocking signal at the UUT is set to the level provided in the table corresponding to the receiver category and type of equipment. It shall be verified and recorded in the test report that the performance criteria as specified in clause 4.3.1.12.3 or clause 4.3.2.11.3 is met.

Step 5:

- Repeat step 4 for each remaining combination of frequency and level for the blocking signal as provided in the table corresponding to the receiver category and type of equipment.

Step 6:

- For non-frequency hopping equipment, repeat step 2 to step 5 with the UUT operating at the highest operating channel.

4.10.4 Test Result

Please refer to the Appendix G.8 for 2.4G WIFI RF Test Data.





5. LIST OF MEASURING EQUIPMENT

Item	Equipment	Manufacturer	Model No.	Serial No.	Cal Date	Due Date
1	X-series USB Peak and Average Power Sensor Agilent	Agilent	U2021XA	MY54080022	2023-10-20	2024-10-19
2	4 CH. Simultaneous Sampling 14 Bits 2MS/s	Agilent	U2531A	MY54080016	2023-10-20	2024-10-19
3	Test Software	Ascentest	AT890-SW	20160630	N/A	N/A
4	RF Control Unit	Ascentest	AT890-RFB	N/A	2023-06-09	2024-06-08
5	MXA Signal Analyzer	Agilent	N9020A	MY49061051	2023-06-09	2024-06-08
6	DC Power Supply	Agilent	E3642A	N/A	2023-10-18	2024-10-17
7	MXG Vector Signal Generator	Agilent	N5182A	MY47071151	2023-06-09	2024-06-08
8	ESG Vector Signal Generator	Agilent	E4438C	MY49072627(3 G)	2023-06-09	2024-06-08
9	PSG Analog Signal Generator	Agilent	E8257D	MY4520521	2023-06-09	2024-06-08
10	Temperature & Humidity Chamber	GUANGZHOU GOGNWEN	GDS-100	70932	2023-10-05	2024-10-04
11	EMI Test Software	Farad	EZ	/	N/A	N/A
12	3m Full Anechoic Chamber	MRDIANZI	FAC-3M	MR009	2022-08-17	2025-08-16
13	Positioning Controller	Max-Full	MF7802BS	MF780208586	N/A	N/A
14	Active Loop Antenna	SCHWARZBECK	FMZB 1519B	00005	2021-08-29	2024-08-28
15	By-log Antenna	SCHWARZBECK	VULB9163	9163-470	2021-09-12	2024-09-11
16	Horn Antenna	SCHWARZBECK	BBHA 9120D	9120D-1925	2021-09-05	2024-09-04
17	Broadband Horn Antenna	SCHWARZBECK	BBHA 9170	791	2021-08-29	2024-08-28
18	Broadband Preamplifier	SCHWARZBECK	BBV9719	9719-025	2021-08-29	2024-08-28
19	EMI Test Receiver	R&S	ESR7	101181	2023-08-15	2024-08-14
20	RS SPECTRUM ANALYZER	R&S	FSP40	100503	2023-07-17	2024-07-16
21	Low-frequency amplifier	SchwarzZBECK	BBV9745	00253	2023-10-18	2024-10-17
22	High-frequency amplifier	JS Denki Pte	PA0118-43	JSPA21009	2023-10-18	2024-10-17
23	WIDEBAND RADIO COMMUNICATION TESTER	R&S	CMW 500	103818	2023-06-09	2024-06-08
24	6dB Attenuator	/	100W/6dB	1172040	2023-06-09	2024-06-08
25	3dB Attenuator	/	2N-3dB	/	2023-10-18	2024-10-17



Shenzhen LCS Compliance Testing Laboratory Ltd.

Add: Room 101, 201, Building A and Room 301, Building C, Juji Industrial Park, Yabianxueziwei, Shajing Street, Bao'an District, Shenzhen, Guangdong, China

Tel: +(86) 0755-82591330 | E-mail: webmaster@lcs-cert.com | Web: www.lcs-cert.com

Scan code to check authenticity



6. PHOTOGRAPHS OF TEST SETUP

Please refer to separated files Appendix D for Photographs of Test Setup_RF.

7. PHOTOGRAPHS OF THE EUT

Please refer to separated files Appendix C for Photographs of The EUT.



-----THE END OF REPORT-----

